

ATA

design SIMONE MICHELI



ATA è ispirata alla pop art dalle forme morbide e tondeggianti degli anni Cinquanta. Composta da poltrona e divano, la serie ha un aspetto avvolgente e imprime un segno serenamente deciso all'ambiente. Eppure, nonostante le sue forme scolpite, ATA è una presenza elegante che sa far bella mostra di sé senza essere invadente in spazi pubblici e privati.

ATA recalls the soft rounded shapes of 1950s pop art. With its enveloping look, the series definitely marks the setting that hosts its sofas or chairs. Its sculpted outline is an elegant self-assured statement that could never become loud, either in residential or corporate settings.

ATA
design SIMONE MICHELI

1P / 1S



2P / 2S



3P / 3S



ATA

design SIMONE MICHELI

1P / 1S

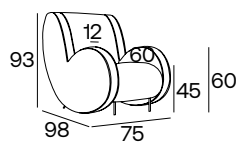

75 cm / 29.53"
98 cm / 38.58"
93 cm / 36.61"
45 cm / 17.72"
60 cm / 23.62"
60 cm / 23.62"
12 cm / 4.72"

 39 kg / 86 Lb

 0.71 m³

 5.00 mtl
tessuto cliente /
customer fabric
H 140 cm

9.30 mtl
pelle cliente /
customer leather

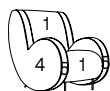

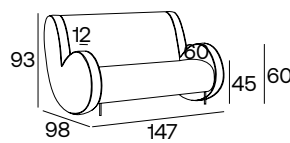

1 - 2.00 mtl
4 - 4.00 mtl
5 - 4.00 mtl

2P / 2S



147 cm / 57.87"
98 cm / 38.58"
93 cm / 36.61"
45 cm / 17.72"
60 cm / 23.62"
60 cm / 23.62"
12 cm / 4.72"

 50 kg / 111 Lb

 1.38 m³

 7.00 mtl
tessuto cliente /
customer fabric
H 140 cm

13.02 mtl
pelle cliente /
customer leather

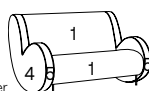

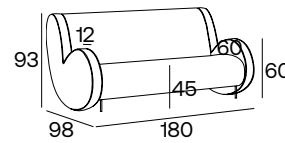

1 - 3.50 mtl
4 - 4.00 mtl
5 - 4.00 mtl

3P / 3S



180 cm / 70.87"
98 cm / 38.58"
93 cm / 36.61"
45 cm / 17.72"
60 cm / 23.62"
60 cm / 23.62"
12 cm / 4.72"

 60 kg / 133 Lb

 1.68 m³

 8.00 mtl
tessuto cliente /
customer fabric
H 140 cm

14.88 mtl
pelle cliente /
customer leather

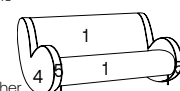

1 - 5.50 mtl
4 - 4.00 mtl
5 - 4.00 mtl

ATA

design SIMONE MICHELI

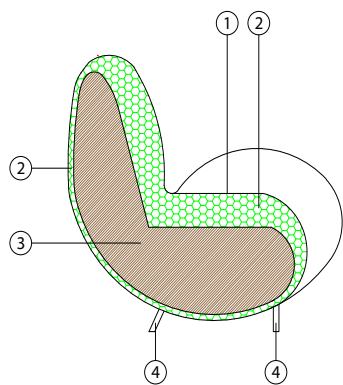

MATERIALI / MATERIALS

- 1 - tessuto/pelle
 - 2 - poliuretano espanso indeformabile di diverse densità e strato di fibra di dacron® 100 gr
 - 3 - telaio in multistrato di legno
 - 4 - piedi tubolari P 43 in metallo verniciato a sezione tonda, Ø 2 cm h 17 cm
- 1 - fabric/leather
2 - high resilience polyurethane foam of different densities and dacron® fiber 100 gr layer
3 - structural frame in plywood
4 - circular varnished tubular metal feet P 43, Ø 2 cm h 17 cm

PIEDI / FEET



CARATTERISTICHE / TECHNICAL FEATURES

SFODERABILITÀ / COVER REMOVAL



VARIANTI / VERSIONS



PIEDI METALLO / METAL FEET



Ral colore a scelta
Ral color of your
choice

RIVESTIMENTI CONSIGLIATI / SUGGESTED FABRICS

VELLUTO / VELVET

LEMMING 29500
CAT. ELEGANT

LUNA/Z CS
CAT. EXTREME

JAQUARD

AMARA
CAT. ELEGANT

ANGEL COMBO
CAT. EXTRA

ANGEL CHEVY
CAT. LUSO

ANGEL JUMBO
CAT. EXTRA

SOLE CS
CAT. ELEGANT

LANA / WOOL

NEMI MELANGE
CAT. LUSO

FENICE
CAT. SUPER

EUROPOST 2
CAT. ELEGANT

BIELASTICO / BIELASTIC

MIRAGE
CAT. LUSO

SPRINT
CAT. LUSO

FINTEPELLI / ARTIFICIAL LEATHER

VINTAGE
CAT. EXTRA

TIFFANY CONTRACT
CAT. LUSO/SUPER

HAPPY
CAT. LUSO/EXTRA

PELLI / LEATHER

MOON
CAT. EXTREME

FLOWER
CAT. ELEGANT

BASIC
CAT. ELEGANT

LUX
CAT. TOP

RÈTRO
CAT. TOP

NABUK
CAT. PLUS

Per la gamma completa di colori, tessuti, pelli ed ecopelli consultare la cartella materiali presente sul sito:
<https://adrenalina.it/finiture/>

For the full range of colours, fabrics, leathers please browse the materials folder on the website:
<https://adrenalina.it/en/finishings/>