

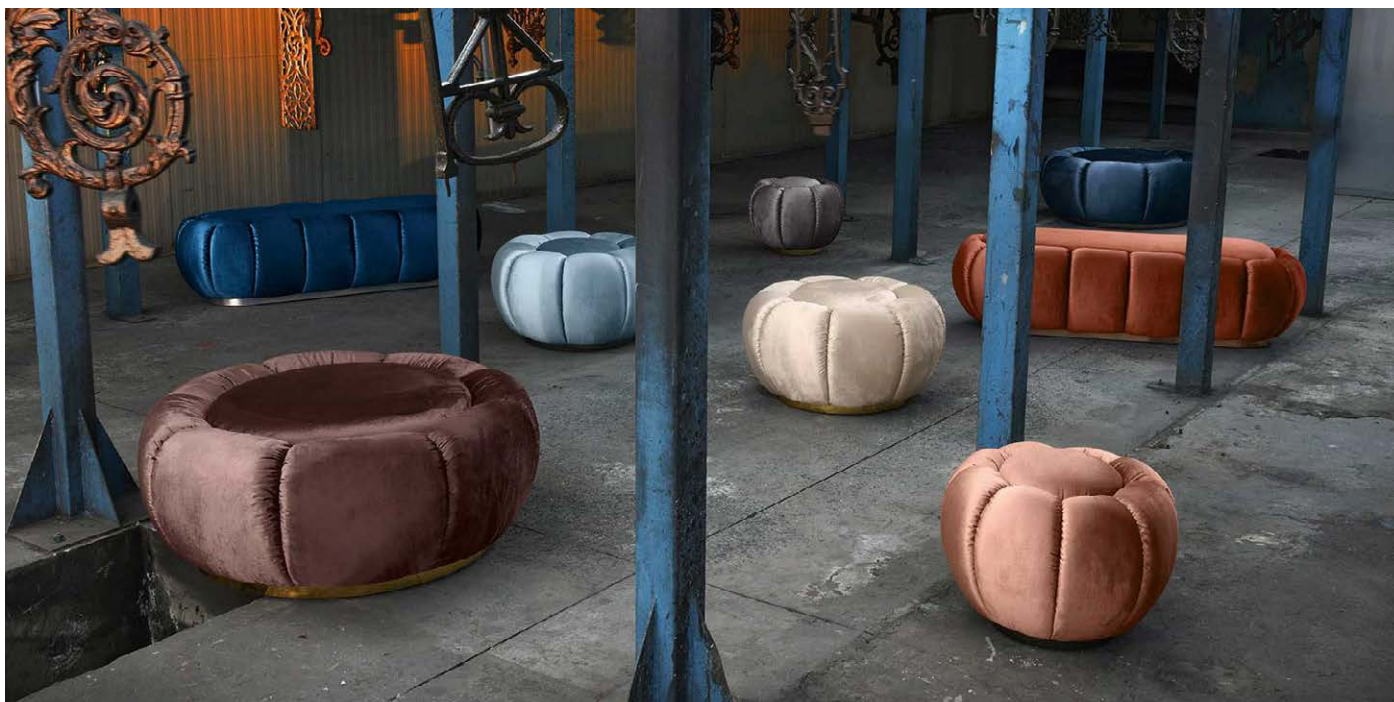

ARKE



Each Arke pouf represents a flower. Available in different sizes, circular or rectangular, it can be covered with all the textiles and leathers of the Domingo collections. The laminated wood base is available in seven colors.

- 1 - dacron® fiber 100 gr;
- 2 - high resilience polyurethane foam of different densities;
- 3 - structural frame in plywood, fir wood and composite wood;
- 4 - plinth in laminated plywood.

ENVIRONMENTAL SUSTAINABILITY

E1 plywood, fir wood and composite wood frame featuring low formaldehyde emission.
Resins and adhesives free of ozone-depleting substances, CFCs and chlorinated solvents.
All the materials are in compliance with EU 91/156 regulations on waste disposal.

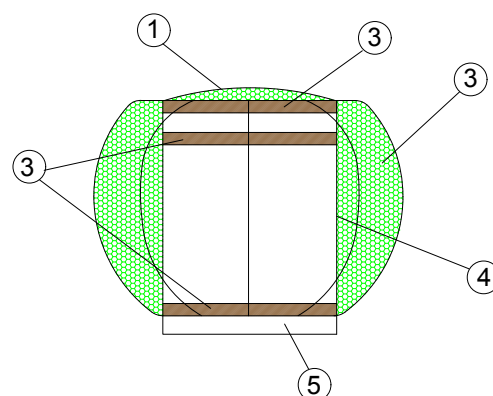

DIMENSIONS

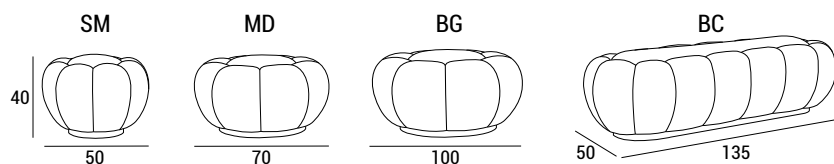

PLINTH

h 3





LAMINATE FINISHINGS



ARPA 0003



ARPA 0211



ARPA 0509



ARPA 4485 GHI

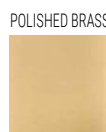

ARPA 2006 LUC



ARPA 2003 SAT



ARPA 2000 SAT



ARPA 2007 CT

SATIN ALU STEEL

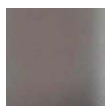





ARPA 2012 SAT

SATIN COPPER CA



ARPA 2008 SAT

TECHNICAL DETAILS

			 fabric mtl H 140 cm	 leather m ²
ARKE SM	6	0.11	2.10	3.91
ARKE MD	11	0.21	3.00	5.58
ARKE BG	28	0.42	4.00	7.44
ARKE BC	23	0.28	4.50	8.37