

Gaber[®]
keep dreaming on **gaber.it**



Jubel SS - Disassembly Direction



JUBEL SS

Disassembly Direction

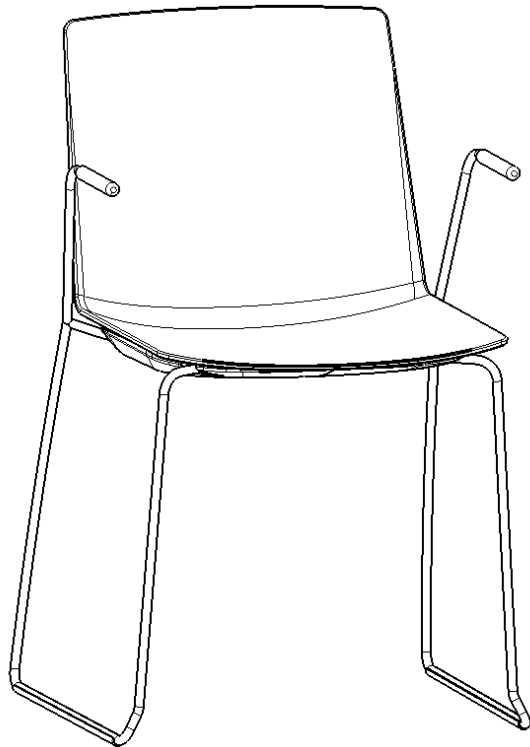

TOOLS

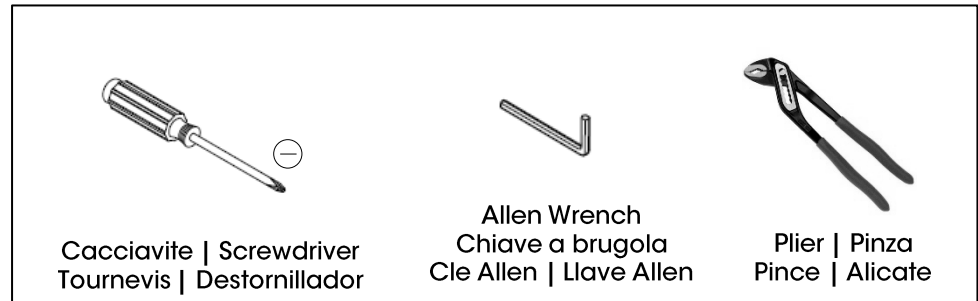



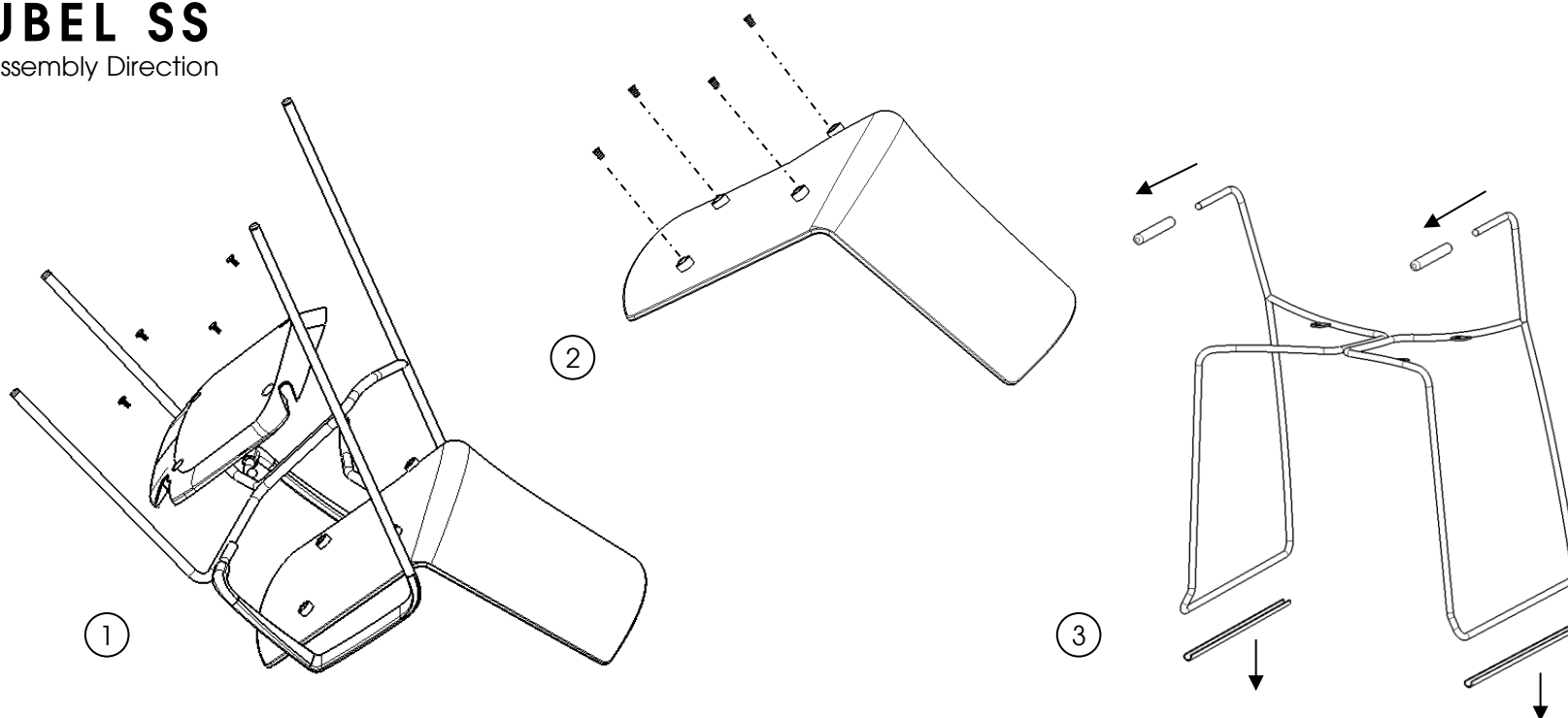

For any question or request, contact your local dealer, or Gaber line at: Per qualsivoglia richiesta, contattare il rivenditore locale, o in alternativa:
Pour toute demande, s'adresser au revendeur le plus proche ou appeler: Para cualquier consulta, llame a su distribuidor local, o alternativamente:

JUBEL SS

Disassembly Direction

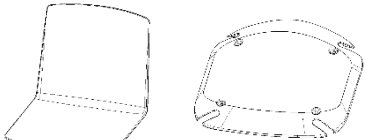

MATERIALS

Polipropylene Polipropilene Polipropylene Polipropileno	Plastomero/Elastomero Plastomère/Elastomère	Polyamide Poliammide Poliamide Poliamida	Steel Acciaio Acier Acero
 (1x) (1x)	 (2x)	 (2x)	 (1x) (4x) (4x)

For proper recycling, arrange the products in different bins, following the information. | Disporre i componenti in contenitori diversi, seguendo quanto indicato per una rapida identificazione e corretto riciclaggio. | Ranger séparément les différents composants, selon la description, de façon à les identifier facilement et en permettre un recyclage correct. | Organice los componentes en diferentes contenedores, siguiendo los pasos descrito para una identificación rápida y un reciclaje adecuado.

IN THE NATURAL RESPECT

Function, design and sustainability



TECHNOPOLYMER

Gaber® production employs exclusively high-tech thermoplastic materials, which are 100% recyclable. Gaber® produces plastic injected materials without added chemicals. Materials purchased within the European Union, in the complete respect of "Reach Regulation".

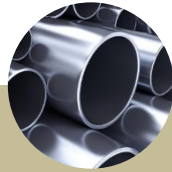

METAL

Metal structures are available with "trivalent" chroming or painted finishes. Prime-quality special epoxy powder coating used on frames enhance color stability from batch to batch and over time, increasing its corrosion resistance and achieving excellent resistance to atmospheric agents.



WOOD

Wooden products are manufactured in accordance with the European Regulations in force regarding formaldehyde emissions from wood-based products. Gaber uses wooden raw materials coming from PEFC chain of custody certified materials.



PACKAGING

Corrugated paperboard carton boxes, printed with environmentally friendly inks, are made of 90% recycled and recyclable materials. Packaging is sized in order to optimize storage and transport requirements, both helping the environment and saving on transport costs.

Each techno-polymer item is marked with a specific symbol, which identifies the kind of polymer for a quick identification and a consequent recycling.