

Luxury living

Divinitas #1



DOMINGO[®]

Luxury living

Divinitas

DOMINGO®

Divinitas, proposte di arredo raffinate per ambienti eleganti, prodotte artigianalmente seguendo la tradizione della migliore manifattura italiana.

Divinitas è un catalogo di divani, poltrone e complementi liberamente ispirati all'universo mitologico classico, con nomi di ninfe ed eroi, figli di dei che hanno tramandato loro la natura "divina" e reminiscenze dell'arte rinascimentale e neoclassica improntata a ideali di bellezza assoluta e alla perfezione.

Divinitas, refined furnishings for elegant spaces, handcrafted according to the best Italian tradition.

Divinitas is a collection of sofas, armchairs and selected accessories reminiscent of the ideals of absolute beauty and perfection as defined by Renaissance and Neoclassical Art. The names of all featured items are borrowed from nymphs and heroes who were the offspring of Gods, therefore semi-divine.

Divinitas, изысканная мебель для элегантных интерьеров, изготовленная в лучших традициях итальянского ручного мастерства.

Divinitas — это каталог диванов, кресел и других предметов интерьера, лейтмотивно перекликающихся с миром классической мифологии своими названиями по именам нимф и героев, - детей богов, перенесших на эту мебель своё божественное совершенство, - и с искусством эпохи Ренессанса и неоклассицизма, в основе которого лежит идеал абсолютной красоты.

Thalia	9		
Dione	51	Pouf Poufs Пуфы	
Cleio	77		
Nefele	95		
		Arke	121
		Dione	131
		Eos	143
		Chione	153
		Tara	163
		Tavoli Tables Столики	
Febe	175	Finiture Finishings отделка	202
Ceo	183	Tessuti e pelli Fabrics and leathers Ткани и кожа	205
Teti	189		
Rea	195		

Divani
Sofas
Диваны

Thalia

9

Dione

51

Cleio

77

Nefele

95



Pouf
Poufs
Пуфы

Arke

121

Dione

131

Eos

143

Chione

153



Tara

163



Tavoli
Tables
Столики

Febe

175

Ceo

183

Teti

189

Rea

195





Divani Sofas Диваны

07

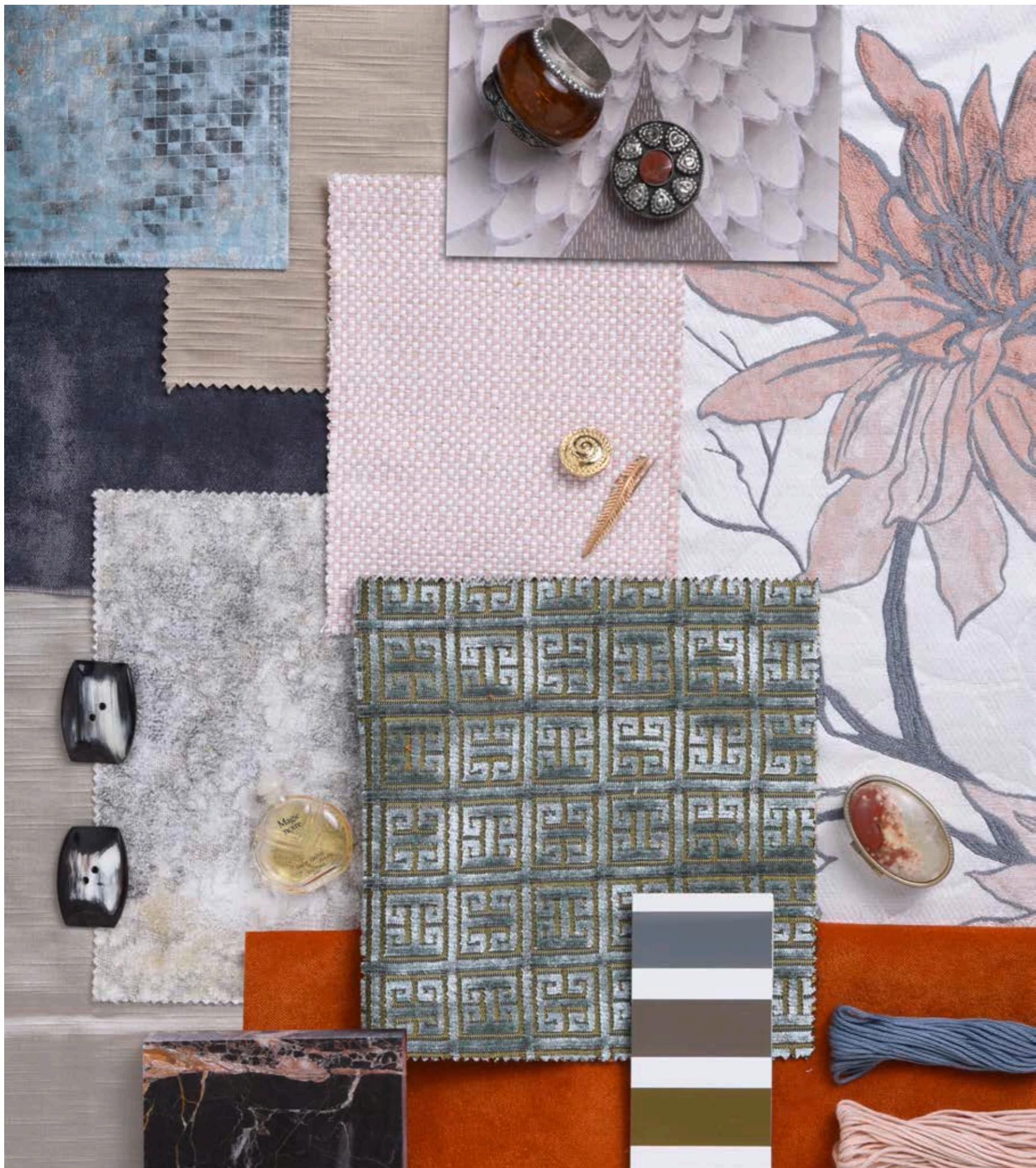

Aspetto deciso e forme imponenti ispirate a Thalia, la musa della commedia e della poesia giocosa, per una presenza che lascia il segno nell'ambiente.

Bold and imposing as the muse of comedy and playful poetry, Thalia will leave its mark wherever it stands.

Внушительные формы и четкие линии, вдохновленные Талией, - музой комедии и легкой поэзии, - накладывают свой отпечаток на интерьер.



Thalia





Divani Sofas Диваны
Domingo—Luxury

Thalia









Divani Sofas Диваны
Domingo—Luxury

Thalia







Divani Sofas Диваны
Domingo—Luxury

Thalia





Divani Sofas Диваны
Domingo—Luxury

Thalia















DIVANO SOFA ДИВАН
3P 226x113xh123
4P 296x113xh123

**Lavorazione schienale interno / Inside backrest version /
Внутренняя обивка спинки**

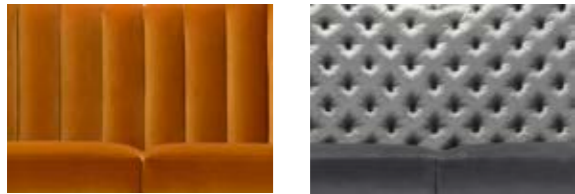

Flute

Capitonné

**Finiture laminato / Laminate finishings /
Ламинированный деревянный цоколь**



Palette laminati
a pag. 202
Page 202 laminated
frame palette
Палитра отделок
ламината на стр. 202

Thalia

Struttura in multistrato di abete in vari spessori, cl. E1 a bassa emissione di formaldeide. Imbottitura in poliuretano espanso indeformabile in densità da 30 a 40 kg/m³ e ovatta in poliestere. Cinghie elastiche da 80 mm. Base in legno laminato in vari colori. Resine e collanti utilizzati sono privi di sostanze ozonolesive, CFC e solventi clorurati. Tutti i materiali impiegati rispettano la normativa EU 91/156 per lo smaltimento dei rifiuti. Prodotto lavorato interamente a mano in Italia.

E1 fir plywood frame (thickness varies) featuring low formaldehyde emission. 30 to 40 kg/m³ non-deformable polyurethane foam padding and polyester wadding 80 mm elastic straps. Laminated wood base (various colours available). The resins and adhesives we use are free of ozone-depleting substances, CFCs and chlorinated solvents. All the materials we use are in compliance with EU 91/156 regulations on waste disposal. Entirely handmade in Italy.

Структура - многослойная фанера из ели разной толщины класса E1 с низкой эмиссией формальдегида. Внутреннее наполнение – недеформируемый пенополиуретан плотностью от 30 до 40 кг/м³ и синтепон. Эластичные ремни шириной 80 мм. Ламинированный деревянный цоколь может быть выполнен в различных цветах. Используемые типы смол и клеящих материалов не содержат озоноразрушающих веществ, хлорфторуглеродов и хлорсодержащих растворителей. Все материалы соответствуют требованиям EU 91/156 по утилизации отходов. Изделия ручной работы, полностью произведенные в Италии.

Thalia capitonné 3P Pag. 18



25,5 |
123
47
113
76,5 | 226 | 35

Rivestimento / Upholstery / Обивочная ткань
 1-8336/5
 2-Tivoli/67
 3-Karma/50 Platino
 4-19554 Don Rodrigo/72 opale



Base in laminato 2007 vg CT
Laminata base 2007 vg CT
Цоколь: ламинат 2007 vg CT

Thalia decor cuscini inclusi / included throw pillows / в комплекте с подушками



1-60X60 1x 2-60X60 2x 3-60X40 2x

Thalia luxury cuscini inclusi / included throw pillows / в комплекте с подушками



1-60X60 3x 2-60X40 2x

La **versione decor** include cuscini decorativi in diversi colori come foto pag. 18.
La **versione luxury** include cuscini monocromatici rivestiti con il medesimo tessuto/pelle del divano.

The **decor version** includes throw pillows made of decorative fabrics, as on page 18.
The **luxury version** includes solid colour throw pillows upholstered with the same fabric/leather used for the sofa.

Версия decor включает подушки разного цвета как на фотографии стр. 18.
Версия luxury включает однотонные подушки, обитые тканью/кожей того же цвета, что и диван.

Cuscini optional pag.17-20-21
Optional pillows p. 17-20-21
Подушки для дополнительного заказа - как на фото на стр. 17-20-21

- 1-8336/5
- 3-Karma/50 Platino



60X60 1x

Thalia capitonné 4P Pag. 10



25,5 |
123
47
113
76,5 | 296 | 35

Rivestimento / Upholstery / Обивочная ткань
 1-Basic/443 Mauritius
 2-Tivoli/29
 3-Orfeo F7292/01 Mint
 4-Vegas Velvet Plain 1403/02
 5-Vegas Velvet Plain 1403/61



Base in laminato 2006 vg LUC
Laminata base 2006 vg LUC
Цоколь: ламинат 2006 vg LUC

Thalia decor cuscini inclusi / included throw pillows / в комплекте с подушками



1-60X60 1x 2-60X60 2x 3-60X60 2x 4-60X40 2x 5-60X40 1x

Thalia luxury cuscini inclusi / included throw pillows / в комплекте с подушками



1-60X60 5x 2-60X40 3x

La **versione decor** include cuscini decorativi in diversi colori come foto pag. 10.
La **versione luxury** include cuscini monocromatici rivestiti con il medesimo tessuto/pelle del divano.

The **decor version** includes throw pillows made of decorative fabrics, as on page 10.
The **luxury version** includes solid colour throw pillows upholstered with the same fabric/leather used for the sofa.

Версия decor включает подушки разного цвета как на фотографии стр. 10.
Версия luxury включает однотонные подушки, обитые тканью/кожей того же цвета, что и диван.

Thalia flute 3P Pag. 36



Rivestimento / Upholstery / Обивочная ткань
 1 -G075/338
 2 -Tivoli/11
 3 -Small velvet/45076



Base in laminato 4485 GHI
 Laminate base 4485 GHI
 Цоколь: ламинат 4485 GHI

Thalia decor cuscini inclusi / included throw pillows / в комплекте с подушками

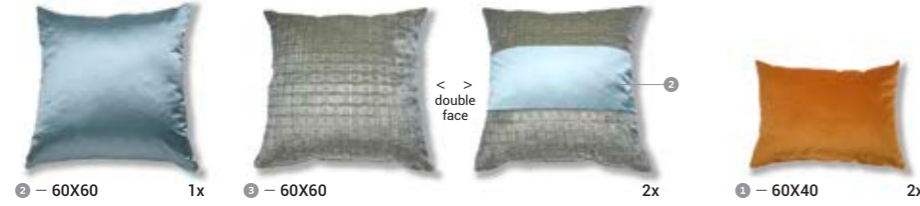

Thalia luxury cuscini inclusi / included throw pillows / в комплекте с подушками



La **versione decor** include cuscini decorativi in diversi colori come foto pag. 36. La **versione luxury** include cuscini monocromatici rivestiti con il medesimo tessuto/pelle del divano.

The **decor version** includes throw pillows made of decorative fabrics, as on page 36. The **luxury version** includes solid colour throw pillows upholstered with the same fabric/leather used for the sofa.

Версия decor включает подушки разного цвета как на фотографии стр. 36. **Версия luxury** включает однотонные подушки, обитые тканью/кожей того же цвета, что и диван.

Thalia flute 3P Pag. 31

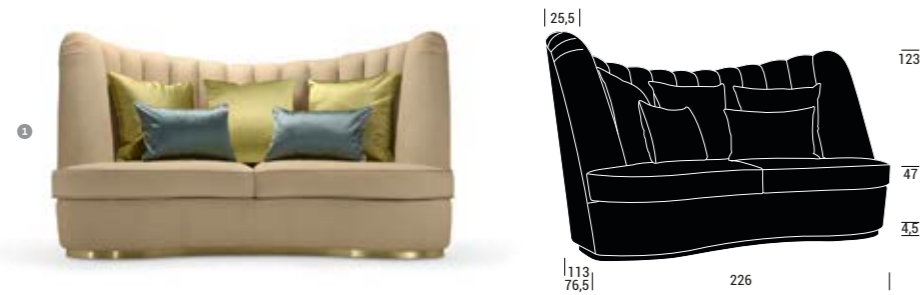

Rivestimento / Upholstery / Обивочная ткань
 1 -Nabuk/03
 2 -Tivoli/08
 3 -Tivoli/64
 Filetto Piping Кант: Tivoli/29



Base in laminato 2003 vg SAT
 Laminate base 2003 vg SAT
 Цоколь: ламинат 2003 vg SAT

Thalia decor cuscini inclusi / included throw pillows / в комплекте с подушками



Thalia luxury cuscini inclusi / included throw pillows / в комплекте с подушками



La **versione decor** include cuscini decorativi in diversi colori come foto pag. 31. La **versione luxury** include cuscini monocromatici rivestiti con il medesimo tessuto/pelle del divano.

The **decor version** includes throw pillows made of decorative fabrics, as on page 31. The **luxury version** includes solid colour throw pillows upholstered with the same fabric/leather used for the sofa.

Версия decor включает подушки разного цвета как на фотографии стр. 31. **Версия luxury** включает однотонные подушки, обитые тканью/кожей того же цвета, что и диван.

Thalia flute 4P Pag. 42-45



Rivestimento / Upholstery / Обивочная ткань
 1 -Moon/651
 Rosa antico
 2 -Brooklin/07
 3 -Kauai Blush F1299/01
 4 -19552 Dalia/90



Base in laminato 2008 vg SAT
 Laminate base 2008 vg SAT
 Цоколь: ламинат 2008 vg SAT

Thalia decor cuscini inclusi / included throw pillows / в комплекте с подушками



Thalia luxury cuscini inclusi / included throw pillows / в комплекте с подушками



La **versione decor** include cuscini decorativi in diversi colori come foto pag. 42-45. La **versione luxury** include cuscini monocromatici rivestiti con il medesimo tessuto/pelle del divano.

The **decor version** includes throw pillows made of decorative fabrics, as on page 42-45. The **luxury version** includes solid colour throw pillows upholstered with the same fabric/leather used for the sofa.

Версия decor включает подушки разного цвета как на фотографии стр. 42-45. **Версия luxury** включает однотонные подушки, обитые тканью/кожей того же цвета, что и диван.

Cuscini optional pag.44
Optional pillows p.44
Подушки для дополнительного заказа - как на фото на стр. 44

- 1 -Kauai Blush F1299/01
- 2 -19552 Dalia/90



Thalia flute 4P Pag. 26-27-28



Rivestimento / Upholstery / Обивочная ткань
 1 -Vegas Velvet Plain 1403/78
 2 -Java Putty F0496/41
 3 -La Moulade NCF4280/05 Blue/Linen
 4 -Java Sesame F0496/45



Base in laminato 2006 vg LUC
 Laminate base 2006 vg LUC
 Цоколь: ламинат 2006 vg LUC

Thalia decor cuscini inclusi / included throw pillows / в комплекте с подушками



Thalia luxury cuscini inclusi / included throw pillows / в комплекте с подушками



La **versione decor** include cuscini decorativi in diversi colori come foto pag. 26-27-28. La **versione luxury** include cuscini monocromatici rivestiti con il medesimo tessuto/pelle del divano.

The **decor version** includes throw pillows made of decorative fabrics, as on page 26-27-28. The **luxury version** includes solid colour throw pillows upholstered with the same fabric/leather used for the sofa.

Версия decor включает подушки разного цвета как на фотографии стр. 26-27-28. **Версия luxury** включает однотонные подушки, обитые тканью/кожей того же цвета, что и диван.

Cuscini optional pag.23-24-25
Optional pillows p.23-24-25
Подушки для дополнительного заказа - как на фото на стр. 23-24-25

- 1 -Vegas Velvet Plain 1403/78
- 2 -Java Putty F0496/41





Rotondità sinuose
 impreziosite da decori discreti,
 proposte colore delicate
 e senza tempo per Dione,
 una collezione ispirata
 alla dea dell'amore, dell'acqua
 e del cielo luminoso.

Sinuous curves embellished
 by sober decorations
 and delicate timeless hues
 for Dione, the series inspired
 by the goddess of love,
 water and clear skies.

Мягкие округленные
 формы, украшенные
 сдержанным декором,
 нежные и неподвластные
 времени цвета
 для коллекции Dione,
 вдохновленной
 богиней любви, воды
 и ясного неба.



Dione





Divani Sofas Диваны
Domingo—Luxury

Dione









Divani Sofas Диваны
Domingo—Luxury

Dione







POLTRONA ARMCHAIR ДИВАН	DIVANO SOFA ДИВАН	POUF POUF ПУФ
Small 80x85xh94	3P 242x118xh97 	Sm D50xh45
Light 80x85xh94		Md D70xh45
Large 118x118xh97		Bc 120x45xh45

Finiture base / Base finishings / Отделки базы



Con frangia
With fringe
С бахромой



Senza frangia
Without fringe
Без бахромы

Dione

Struttura in multistrato di abete in vari spessori, cl. E1 a bassa emissione di formaldeide. Imbottitura in poliuretano espanso indeformabile in densità da 30 a 40 kg/m³ e ovatta in poliestere. Cinghie elastiche da 80 mm. Versione letto con sistema di apertura rapida a due pieghe, rete elettrosaldata e materasso h 12 cm. Frangia in filato di organzino. Resine e collanti utilizzati sono privi di sostanze ozonolesive, CFC e solventi clorurati. Tutti i materiali impiegati rispettano la normativa EU 91/156 per lo smaltimento dei rifiuti.

E1 fir plywood frame featuring low formaldehyde emission. 30 to 40 kg/m³ non-deformable polyurethane foam padding and polyester wadding 80 mm elastic straps. The sofa-bed version features a quick two-fold opening system, electro-welded mesh two fold and 12 cm height mattress. Fringe in organzine yarn. The resins and adhesives we use are free of ozone-depleting substances, CFCs and chlorinated solvents. All the materials we use are in compliance with EU 91/156 regulations on waste disposal.

Структура - многослойная фанера из ели разной толщины класса E1 с низкой эмиссией формальдегида. Внутреннее наполнение - недеформируемый пенополиуретан плотностью от 30 до 40 кг/м³ и синтепон. Эластичные ремни шириной 80 мм. Версия со спальным местом имеет механизм быстрого раскладывания в два приема, электросварную сетку и матрас см h12. Бахрома - шелковая глянцевая пряжа. Используемые типы смол и клеящих материалов не содержат озоноразрушающих веществ, хлорфторуглеродов и хлорсодержащих растворителей. Все материалы соответствуют требованиям EU 91/156 по утилизации отходов.



Dione light 1P

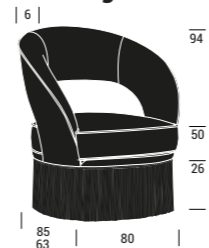

Pag. 64



Rivestimento / Upholstery / Обивочная ткань
 ①-G075/857
 ②-Frangia fringe Бахрома h26/9R STD
 Chiodini in oro invecchiato
 Aged golden nails
 Заклепки под состарившееся золото



Rivestimento / Upholstery / Обивочная ткань
 ①-G075/102
 Filetto Piping Кант: G075/234
 ②-Frangia fringe Бахрома h26/2R STD
 Chiodini in oro invecchiato
 Aged golden nails
 Заклепки под состарившееся золото

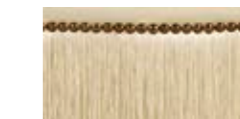

Rivestimento / Upholstery / Обивочная ткань
 ①-G075/234
 Filetto Piping Кант: G075/102
 ②-Frangia fringe Бахрома h26/2R STD
 Chiodini in oro invecchiato
 Aged golden nails
 Заклепки под состарившееся золото



Dione small 1P

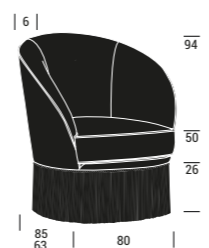

Pag. 64



Rivestimento / Upholstery / Обивочная ткань
 ①-G075/230
 ②-Frangia fringe Бахрома h26/10R STD
 Chiodini in oro invecchiato
 Aged golden nails
 Заклепки под состарившееся золото



Rivestimento / Upholstery / Обивочная ткань
 ①-G075/312
 ②-Frangia fringe Бахрома h26/11R STD
 Chiodini in oro invecchiato
 Aged golden nails
 Заклепки под состарившееся золото



Rivestimento / Upholstery / Обивочная ткань
 ①-G075/462
 ②-Frangia fringe Бахрома h26/57R STD
 Chiodini in oro invecchiato
 Aged golden nails
 Заклепки под состарившееся золото



Dione large 1P

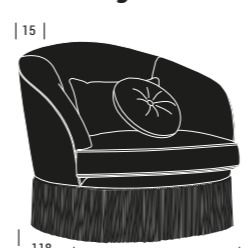

Pag. 62



Rivestimento / Upholstery / Обивочная ткань
 ①-Lux/2408
 ②-Frangia fringe Бахрома h26/29R STD
 ③-80723 Crusca/46 Rame rosato
 ④-Java Coccoa F0496/08 Bottone Button Пуговица: Lux/2408
 Chiodini in oro invecchiato
 Aged golden nails
 Заклепки под состарившееся золото

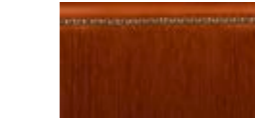

La **versione decor** include cuscini decorativi in diversi colori come foto pag. 62-63. La **versione luxury** include cuscini monocromatici rivestiti con il medesimo tessuto/pelle del divano.

The **decor version** includes throw pillows made of decorative fabrics, as on page 62-63.

The **luxury version** includes solid colour throw pillows upholstered with the same fabric/leather used for the sofa.

Версия **decor** включает подушки разного цвета как на фотографии стр. 62-63. Версия **luxury** включает однотонные подушки, обитые тканью/кожей того же цвета, что и диван.

Divani Sofas Диваны
Domingo—Luxury

Pag. 63

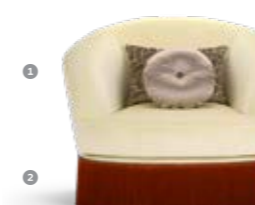

Rivestimento / Upholstery / Обивочная ткань
 ①-G075/102
 ②-Frangia fringe Бахрома h26/29R STD
 ③-Vimini/44
 ④-Java Putty F0496/41 Bottone Button Пуговица: Java Coccoa F0496/08
 Chiodini in oro invecchiato
 Aged golden nails
 Заклепки под состарившееся золото



Dione

Dione decor



① - 60X40 1x



④ - Ø45 1x

cuscini inclusi / included throw pillows / в комплекте с подушками

Dione luxury



① - 60X40 1x

cuscini inclusi / included throw pillows / в комплекте с подушками

Dione decor



① - 60X40 1x



④ - Ø45 1x

cuscini inclusi / included throw pillows / в комплекте с подушками

Dione luxury



① - 60X40 1x

cuscini inclusi / included throw pillows / в комплекте с подушками

Dione 3P Pag. 56



Rivestimento / Upholstery / Обивочная ткань
 1-G075/234
 2-Frangia fringe Бахрома h26/72R STD
 3-Diamond Luxury/01
 4-Mirage Luxury/01
 5-Java Moss F0496/33
 Bottone Button Пуговица: G075/234
 Chiodini in oro invecchiato Aged golden nails
 Заклепки под состарившееся золото

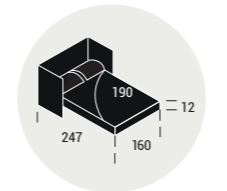

Dione decor cuscini inclusi / included throw pillows / в комплекте с подушками



1 - 60X40 1x 2 - 60X40 2x 3 - 35X25 2x 4 - 35X25 2x 5 - Ø45 1x

Dione luxury cuscini inclusi / included throw pillows / в комплекте с подушками



1 - 60X40 3x 2 - 35X25 4x

La **versione decor** include cuscini decorativi in diversi colori come foto pag. 56. La **versione luxury** include cuscini monocromatici rivestiti con il medesimo tessuto/pelle del divano.

The **decor version** includes throw pillows made of decorative fabrics, as on page 56. The **luxury version** includes solid colour throw pillows upholstered with the same fabric/leather used for the sofa.

Версия decor включает подушки разного цвета как на фотографии стр. 56. **Версия luxury** включает однотонные подушки, обитые тканью/кожей того же цвета, что и диван.

Dione 3P Pag. 51-55



Rivestimento / Upholstery / Обивочная ткань
 1-G075/102
 2-Frangia fringe Бахрома h26/29R STD
 3-Vimini/10
 4-Java Coccoa F0496/08
 5-Java Putty F0496/41
 Bottone Button Пуговица: Java Coccoa F0496/08
 Chiodini in oro invecchiato Aged golden nails
 Заклепки под состарившееся золото

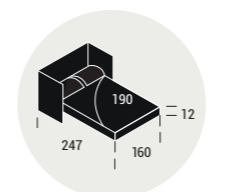

Dione decor cuscini inclusi / included throw pillows / в комплекте с подушками



1 - 60X40 1x 2 - 60X40 2x 3 - 35X25 2x 4 - 35X25 2x 5 - Ø45 1x

Dione luxury cuscini inclusi / included throw pillows / в комплекте с подушками



1 - 60X40 3x 2 - 35X25 4x

La **versione decor** include cuscini decorativi in diversi colori come foto pag. 51-55. La **versione luxury** include cuscini monocromatici rivestiti con il medesimo tessuto/pelle del divano.

The **decor version** includes throw pillows made of decorative fabrics, as on page 51-55. The **luxury version** includes solid colour throw pillows upholstered with the same fabric/leather used for the sofa.

Версия decor включает подушки разного цвета как на фотографии стр. 51-55. **Версия luxury** включает однотонные подушки, обитые тканью/кожей того же цвета, что и диван.

Cuscini optional pag.52
Optional throw pillows p.52
Подушки для дополнительного заказа - как на фото на стр. 52
 1-Vimini/44
 2-Java Dove F0496/10
 Bottone Button Пуговица: G075/102



Dione Sm pouf Pag. 68

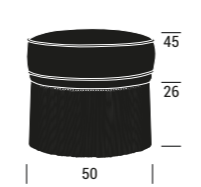

Rivestimento / Upholstery / Обивочная ткань
 1-G075/102
 2-Frangia fringe Бахрома h26/72R STD
 Chiodini in oro invecchiato Aged golden nails
 Заклепки под состарившееся золото



Rivestimento / Upholstery / Обивочная ткань
 1-G075/102
 2-Frangia fringe Бахрома h26/29R STD
 Chiodini in oro invecchiato Aged golden nails
 Заклепки под состарившееся золото



Dione Md pouf Pag. 68

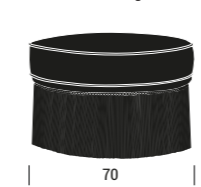

Rivestimento / Upholstery / Обивочная ткань
 1-G075/208
 2-Frangia fringe Бахрома h26/254R STD
 Chiodini in oro invecchiato Aged golden nails
 Заклепки под состарившееся золото



Rivestimento / Upholstery / Обивочная ткань
 1-80723 Crusca/46 Rame rosato
 2-Frangia fringe Бахрома h26/79R OPT
 Chiodini in oro invecchiato Aged golden nails
 Заклепки под состарившееся золото



Dione Bc bench Pag. 68



Rivestimento / Upholstery / Обивочная ткань
 1-G075/456
 2-Frangia fringe Бахрома h26/79R OPT
 Chiodini in oro invecchiato Aged golden nails
 Заклепки под состарившееся золото



Rivestimento / Upholstery / Обивочная ткань
 1-8336/15
 2-Frangia fringe Бахрома h26/29R STD
 Chiodini in oro invecchiato Aged golden nails
 Заклепки под состарившееся золото



Frangia / Fringe / Бахрома / h26 cm

STD = colori di serie / standard colours / стандартные цвета
 OPT = colori optional / optional colours / по желанию
 (за дополнительную плату)

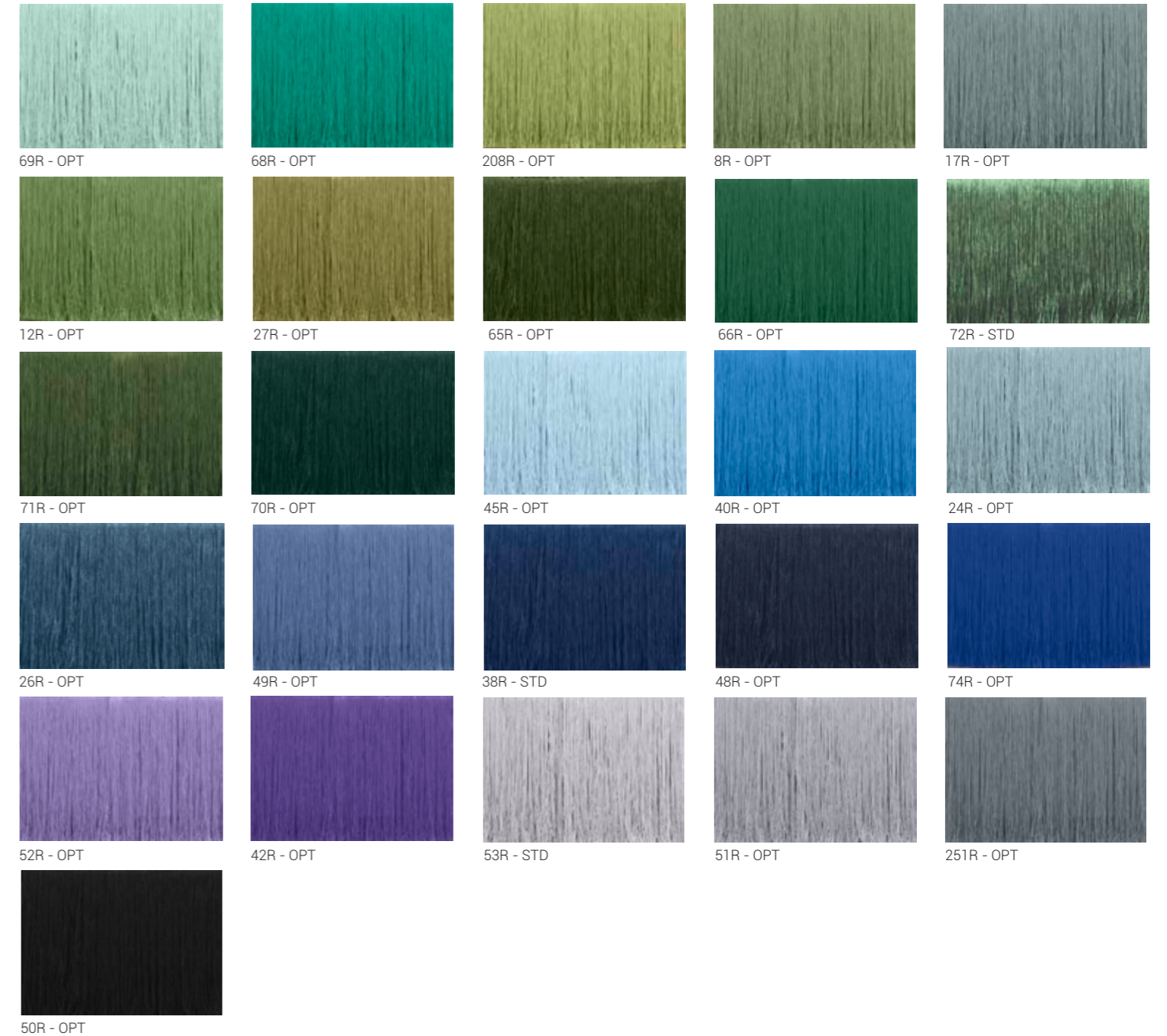

Chiodini metallici / Metal nails / Металлические заклепки





Forme classiche rivisitate
con dettagli moderni,
geometrie lineari
e curve che si incontrano
armoniosamente nelle sedute
di Cleio, la collezione ispirata
alla musa della storia
e protettrice della poesia.

Modern details add charm
and personality to classic
shapes that harmoniously
combine linear and round
geometrical features to define
Cleio, a series of sofas
and armchairs that bears
the name of the Muse of History
invoked by the poets who sang
the deeds of the great.

Классические формы с
современными деталями,
чистые геометрические
линии и изгибы,
гармонично сливающиеся
в сиденьях коллекции Cleio,
посвященной музе истории,
воспетой поэтами.



Cleio





Divani Sofas Диваны
Domingo—Luxury

Cleio









POLTRONA ARMCHAIR КРЕСЛО	DIVANO SOFA ДИВАН
Small 85x99.5xh86	2P 198x113xh89.5 
Large 110x113xh89.5	3P 255x113xh89.5 

Lavorazione scocca esterna / Outer shell version / Внешняя обивка каркаса



Liscio
Plain
Гладкая

Capitonnè

Lavorazione schienale interno / Inside backrest version / Внутренняя обивка спинки



Liscio
Plain
Гладкая

Flute

Cleio

Struttura in multistrato di abete in vari spessori, cl. E1 a bassa emissione di formaldeide. Imbottitura in poliuretano espanso indeformabile in densità da 30 a 40 kg/m³ e ovatta in poliestere. Cinghie elastiche da 80 mm. Piedi in metallo con finitura galvanica ottone e protezione trasparente. Versione letto con sistema di apertura rapida a due pieghe, rete elettrosaldata e materasso 12 cm. Resine e collanti utilizzati sono privi di sostanze ozonolesive, CFC e solventi clorurati. Tutti i materiali impiegati rispettano la normativa EU 91/156 per lo smaltimento dei rifiuti.

E1 fir plywood frame (thickness varies) featuring low formaldehyde emission. 30 to 40 kg/m³ non-deformable polyurethane foam padding and polyester wadding 80 mm elastic straps. Metal feet with galvanised brass finish and transparent protection. The resins and adhesives we use are free of ozone-depleting substances, CFCs and chlorinated solvents. The sofa-bed version features a quick two-fold opening system, electro-welded mesh two fold and 12 cm height mattress All the materials we use are in compliance with EU 91/156 regulations on waste disposal.

Структура - многослойная фанера из ели разной толщины класса E1 с низкой эмиссией формальдегида. Внутреннее наполнение - недеформируемый пенополиуретан плотностью от 30 до 40 кг/м³ и синтепон. Эластичные ремни шириной 80 мм. Ножки - металл с гальванической латунной отделкой и прозрачным защитным покрытием. Используемые типы смол и клеящих материалов не содержат озоноразрушающих веществ, хлорфторуглеродов и хлорсодержащих растворителей. Версия со спальным местом имеет механизм быстрого раскладывания в два приема, электросварную сетку и матрас см h12. Все материалы соответствуют требованиям EU 91/156 по утилизации отходов.



Cleio small plain 1P

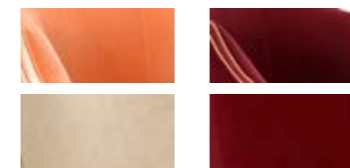
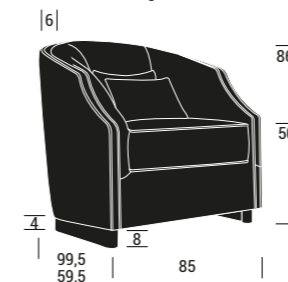

Lavorazione schienale interno-esterno liscio
Plain inside backrest version
Plain outer shell version
Внутренняя и внешняя обивка спинки - гладкая

Pag. 78



Rivestimento /
Upholstery /
Обивочная ткань
①-G075/456
②- Fascia e schienale
Band and shell
Вставка и спинка:
Karma/50 Platino
③-19558 Renzo/50
Bronzo

Base in metallo verniciato
ottone satinato
Metal base with satin
brass finish
Цоколь - металл в цвете
матовой латуни

Pag. 78



Rivestimento /
Upholstery /
Обивочная ткань
①-G075/824
②-G075/456

Base in metallo verniciato
ottone satinato
Metal base with satin
brass finish
Цоколь - металл в цвете
матовой латуни

Cleio large capitonnè 1P

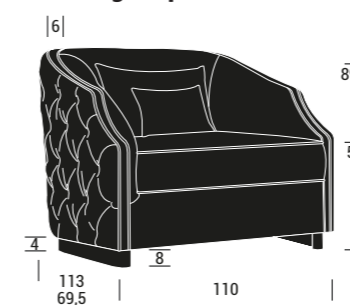

Lavorazione schienale interno liscio
Lavorazione scocca esterna capitonnè
Plain inside backrest version
Capitonnè outer shell version
Внутренняя обивка спинки - гладкая
Внешняя обивка каркаса - каретная
стяжка ("капитоне")

Pag. 82



Rivestimento /
Upholstery /
Обивочная ткань
①-G075/416
②-G075/414

Base in metallo verniciato
ottone satinato
Metal base with satin
brass finish
Цоколь - металл в цвете
матовой латуни

La **versione decor** include cuscini decorativi in diversi colori come foto pag. 78-82. La **versione luxury** include cuscini monocromatici rivestiti con il medesimo tessuto/pelle del divano.

Cleio decor cuscini inclusi / included throw pillows / в комплекте с подушками

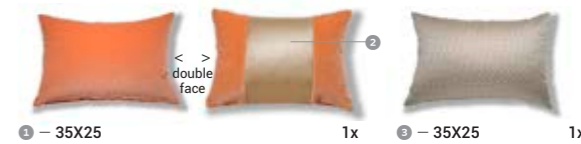

① - 35X25 1x ② - 35X25 1x

Cleio luxury cuscini inclusi / included throw pillows / в комплекте с подушками



① - 35X25 2x

Cleio decor cuscini inclusi / included throw pillows / в комплекте с подушками



① - 35X25 1x ② - 35X25 1x

Cleio luxury cuscini inclusi / included throw pillows / в комплекте с подушками



① - 35X25 2x

Cleio decor cuscini inclusi / included throw pillows / в комплекте с подушками



② - 60X40 1x ③ - 35X25 1x

Cleio luxury cuscini inclusi / included throw pillows / в комплекте с подушками



② - 60X40 1x ③ - 35X25 1x

The **decor version** includes throw pillows made of decorative fabrics, as on page 78-82. The **luxury version** includes solid colour throw pillows upholstered with the same fabric/leather used for the sofa.

Версия decor включает подушки разного цвета как на фотографии стр. 78-82. **Версия luxury** включает однотонные подушки, обитые тканью/кожей того же цвета, что и диван.

Cleio plain 2P

Pag. 78

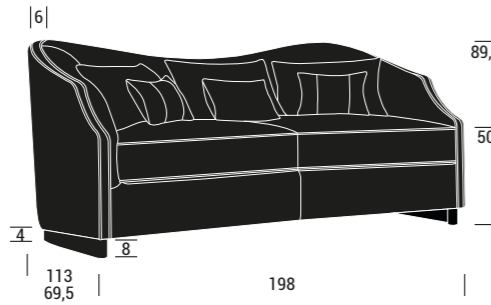

Rivestimento / Upholstery / Обивочная ткань
 1-G075/456
 2-Karma/50 Platino
 3-19558 Renzo/50 Bronzo

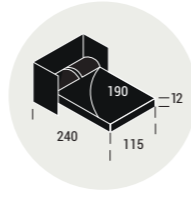

Base in metallo verniciato ottone satinato
 Metal base with satin brass finish
 Цоколь – металл в цвете матовой латуни



Lavorazione schienale interno-esterno liscio
 Plain inside backrest version
 Plain outer shell version
 Внутренняя обивка спинки - гладкая
 Внешняя обивка каркаса - гладкая

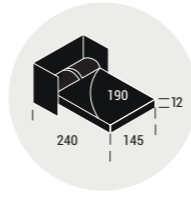

Rivestimento / Upholstery / Обивочная ткань
 1-G075/208
 2-Filetto e schienale Lux/2434 Piping and backrest Lux/2434
 Кант и спинка: Lux/2434
 3-80723 Crusca/46 Rame rosato
 4-Jungle velvet 1638/07



Base in metallo verniciato ottone satinato
 Metal base with satin brass finish
 Цоколь - металл в цвете матовой латуни



Lavorazione schienale interno liscio. Lavorazione scocca esterna capitonné
 Plain inside backrest version
 Capitonné outer shell version
 Внутренняя обивка спинки - гладкая. Внешняя обивка каркаса - каретная стяжка ("капитоне")

Cleio flute 3P

Pag. 86

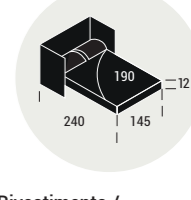
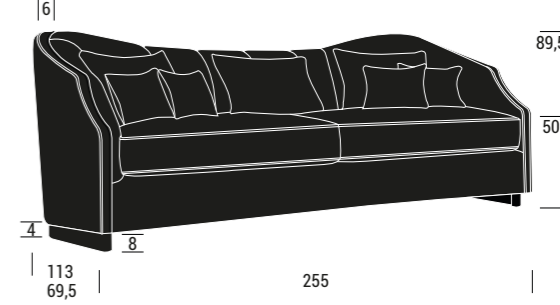

Rivestimento / Upholstery / Обивочная ткань
 1-Bilbi/22
 2-Bahamas/4
 3-Tivoli/29

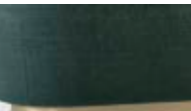

Base in metallo verniciato ottone satinato
 Metal base with satin brass finish
 Цоколь – металл в цвете матовой латуни



Lavorazione schienale interno fasce verticali imbottite. Lavorazione scocca esterna liscio
 Deep fluted backrest
 Plain outer shell version
 Внутренняя отделка спинки - вертикальные сегменты с набивкой
 Внешняя обивка каркаса - гладкая

Cleio decor cuscini inclusi / included throw pillows / в комплекте с подушками**Cleio luxury** cuscini inclusi / included throw pillows / в комплекте с подушками

La **versione decor** include cuscini decorativi in diversi colori come foto pag. 78. La **versione luxury** include cuscini monocromatici rivestiti con il medesimo tessuto/pelle del divano.

The **decor version** includes throw pillows made of decorative fabrics, as on page 78. The **luxury version** includes solid colour throw pillows upholstered with the same fabric/leather used for the sofa.

Версия decor включает подушки разного цвета как на фотографии стр. 78. **Версия luxury** включает однотонные подушки, обитые тканью/кожей того же цвета, что и диван.

Cleio capitonné 3P

Pag. 82

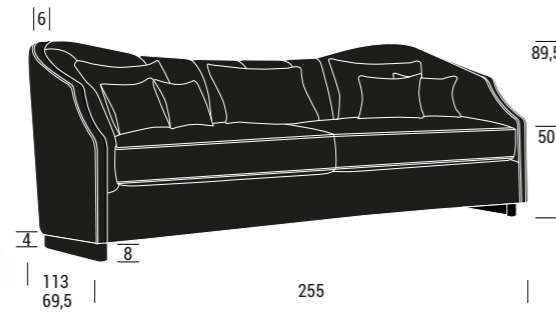
**Cleio decor** cuscini inclusi / included throw pillows / в комплекте с подушками**Cleio luxury** cuscini inclusi / included throw pillows / в комплекте с подушками

La **versione decor** include cuscini decorativi in diversi colori come foto pag. 82. La **versione luxury** include cuscini monocromatici rivestiti con il medesimo tessuto/pelle del divano.

The **decor version** includes throw pillows made of decorative fabrics, as on page 82. The **luxury version** includes solid colour throw pillows upholstered with the same fabric/leather used for the sofa.

Версия decor включает подушки разного цвета как на фотографии стр. 82. **Версия luxury** включает однотонные подушки, обитые тканью/кожей того же цвета, что и диван.

Divani Sofas Диваны

Domingo—Luxury

Cleio



Protagonista assoluto, ricco di dettagli preziosi e capitonné lavorati a mano che ne esaltano la morbidezza, Nefele è ispirato alla ninfa delle nubi, creata da una nuvola grazie all'intervento di Zeus.

An absolute star, rich in sophisticated details and handmade capitonné stitches that enhance its softness, Nefele is inspired by the nymph whom Zeus created out of a cloud.

Главный элемент этой коллекции, украшенный ценными деталями, - стежка "капитоне", мягкие формы которой были созданы благодаря ручной работе; коллекция Nefele посвящена нимфе облаков, так как Нефела была создана Зевсом именно из облака.



Nefele



















POLTRONA
ARMCHAIR
КРЕСЛО

1P 120x119xh95/85

DIVANO
SOFA
ДИВАН

3P 236x119xh95/85

4P 280x119xh95/85

**Lavorazione scocca esterna / Outer shell version /
Внешняя обивка каркаса**



Liscio
Plain
Гладкая

Capitonné

**Lavorazione schienale interno / Inside backrest version /
Внутренняя обивка спинки**



Liscio
Plain
Гладкая

Capitonné

Piedi / Feet / Ножки



P 64 h14 cm
Piede in metallo
finitura ottone lucido
Polished brass-plated
metal legs
Ножка – металл в
отделке блестящая
латунь

P 59 h 4,5 cm
Piede in legno wengé
Wooden feet stained wengé
Деревянные ножки в
цвете венге

Nefelee

Struttura in multistrato di abete in vari spessori, cl. E1 a bassa emissione di formaldeide. Imbottitura in poliuretano espanso indeformabile in densità da 30 a 40 kg/m³ e ovatta in poliestere. Cinghie elastiche da 80 mm. Piedi in metallo con finitura galvanica ottone e protezione trasparente lucido. Versione letto con sistema di apertura rapida a due pieghe, rete elettrosaldada e materasso alto 12 cm. Resine e collanti utilizzati sono privi di sostanze ozonolesive, CFC e solventi clorurati. Tutti i materiali impiegati rispettano la normativa EU 91/156 per lo smaltimento dei rifiuti. Prodotto lavorato interamente a mano in Italia.

E1 fir plywood frame featuring low formaldehyde emission. 30 to 40 kg/m³ non-deformable polyurethane foam padding and polyester wadding 80 mm elastic straps. Metal feet with galvanic brass finish and glossy transparent protection. The sofa-bed version features a rapid, two-fold opening system, and electro-welded mesh two fold and 12 cm height mattress. The resins and adhesives we use are free of ozone-depleting substances, CFCs and chlorinated solvents. All the materials we use are in compliance with EU 91/156 regulations on waste disposal. Entirely handmade in Italy.

Структура – многослойная фанера из ели разной толщины класса E1 с низкой эмиссией формальдегида. Внутреннее наполнение – недеформируемый пенополиуретан плотностью от 30 до 40 кг/м³ и синтепон. Эластичные ремни шириной 80 мм. Ножки – металл с гальванической латунной отделкой и глянцевым прозрачным защитным покрытием. Версия со спальным местом имеет механизм быстрого раскладывания в два приема, электросварную сетку и матрас см h12. Используемые типы смол и клеящих материалов не содержат озоноразрушающих веществ, хлорфторуглеродов и хлорсодержащих растворителей. Все материалы соответствуют требованиям EU 91/156 по утилизации отходов. Изделия ручной работы, полностью произведенные в Италии.

Nefelee capitonné 1P

Pag. 96

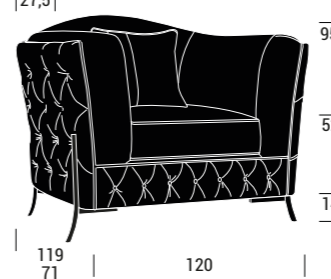

Rivestimento / Upholstery / Обивочная ткань
● Vegas Velvet Plain 1403/83
● Old/1



Lavorazione schienale interno liscio
Lavorazione scocca esterna capitonné
Plain inside backrest version
Capitonné outer shell version
Внутренняя обивка спинки – гладкая
Внешняя обивка каркаса – каретная стяжка ("капитоне")



P 64 Piede in metallo
ottonato lucido
Polished brass-plated
metal legs
Ножка – металл в
отделке блестящая
латунь

Nefelee decor

cuscini inclusi / included throw pillows /
в комплекте с подушками



1 – 45X45

1x

Nefelee luxury

cuscini inclusi / included throw pillows /
в комплекте с подушками



1 – 45X45

1x

La **versione decor** include cuscini decorativi in diversi colori come foto pag. 96. La **versione luxury** include cuscini monocromatici rivestiti con il medesimo tessuto/pelle del divano.

The **decor version** includes throw pillows made of decorative fabrics, as on page 96. The **luxury version** includes solid colour throw pillows upholstered with the same fabric/leather used for the sofa.

Версия decor включает подушки разного цвета как на фотографии стр. 96. **Версия luxury** включает однотонные подушки, обитые тканью/кожей того же цвета, что и диван.

Nefelee capitonné 1P

Pag. 110

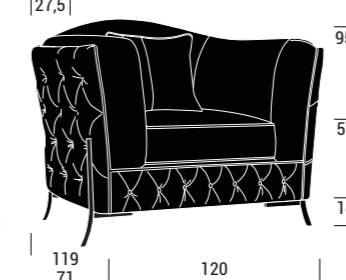

Rivestimento / Upholstery / Обивочная ткань
● 8336/51
● 8336/60
● Java Dove F0496/10

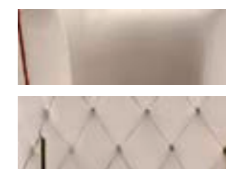

Lavorazione schienale interno liscio
Lavorazione scocca esterna capitonné
Plain inside backrest version
Capitonné outer shell version
Внутренняя обивка спинки – гладкая
Внешняя обивка каркаса – каретная стяжка ("капитоне")



P 64 Piede in metallo
ottonato lucido
Polished brass-plated
metal legs
Ножка – металл в
отделке блестящая
латунь

Nefelee decor

cuscini inclusi / included throw pillows /
в комплекте с подушками



1 – 45X45

1x

Nefelee luxury

cuscini inclusi / included throw pillows /
в комплекте с подушками



1 – 45X45

1x

La **versione decor** include cuscini decorativi in diversi colori come foto pag. 110. La **versione luxury** include cuscini monocromatici rivestiti con il medesimo tessuto/pelle del divano.

The **decor version** includes throw pillows made of decorative fabrics, as on page 110. The **luxury version** includes solid colour throw pillows upholstered with the same fabric/leather used for the sofa.

Версия decor включает подушки разного цвета как на фотографии стр. 110. **Версия luxury** включает однотонные подушки, обитые тканью/кожей того же цвета, что и диван.

Nefelee plain 1P

Pag. 110

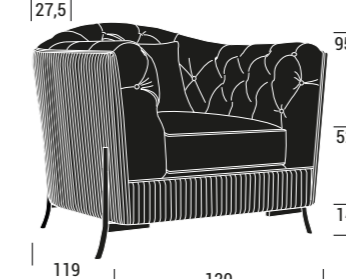

Rivestimento / Upholstery / Обивочная ткань
● 8336/60
● Java Heather F0496/20
● Art.1469/60 trapuntato quilted с прошивкой

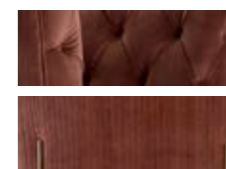

Lavorazione schienale interno capitonné. Lavorazione scocca esterna liscia. Capitonné backrest Plain outer shell version
Внутренняя обивка спинки – "капитоне"
Внутренняя обивка спинки – гладкая

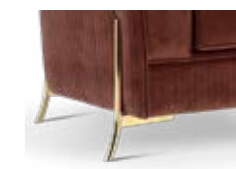

P 64 Piede in metallo
ottonato lucido
Polished brass-plated
metal legs
Ножка – металл в
отделке блестящая
латунь

Nefelee decor

cuscini inclusi / included throw pillows /
в комплекте с подушками



2 – 45X45

1x

Nefelee luxury

cuscini inclusi / included throw pillows /
в комплекте с подушками



1 – 45X45

1x

La **versione decor** include cuscini decorativi in diversi colori come foto pag. 110. La **versione luxury** include cuscini monocromatici rivestiti con il medesimo tessuto/pelle del divano.

The **decor version** includes throw pillows made of decorative fabrics, as on page 110. The **luxury version** includes solid colour throw pillows upholstered with the same fabric/leather used for the sofa.

Версия decor включает подушки разного цвета как на фотографии стр. 110. **Версия luxury** включает однотонные подушки, обитые тканью/кожей того же цвета, что и диван.

Divani Sofas Диваны

Domingo—Luxury

Nefelee

Nefele Plain 3P Pag. 102

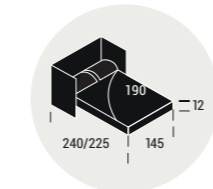
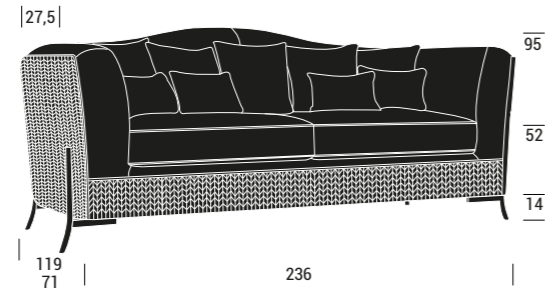

Nefele decor cuscini inclusi / included throw pillows / в комплекте с подушками



1 - 45X45 2x 2 - 45X45 2x 3 - 45X45 1x 4 - 35X25 2x 5 - 35X25 2x

Rivestimento / Upholstery / Обивочная ткань
 1-8336/55
 2-Java Eau de Nil F0496/14
 3-Java Dove F0496/10
 4-Maui Slate F1302/05
 5-Art.1456/55
 trapuntato quilted с прошивкой

Lavorazione schienale interno capitonné
 Lavorazione scocca esterna liscia
 Capitonné backrest Plain outer shell version
 Внутренняя обивка спинки - "капитоне"
 Внутренняя обивка спинки - гладкая

Nefele luxury cuscini inclusi / included throw pillows / в комплекте с подушками



1 - 45X45 5x 2 - 35X25 4x

La **versione decor** include cuscini decorativi in diversi colori come foto pag. 102. La **versione luxury** include cuscini monocromatici rivestiti con il medesimo tessuto/pelle del divano.

The **decor version** includes throw pillows made of decorative fabrics, as on page 102. The **luxury version** includes solid colour throw pillows upholstered with the same fabric/leather used for the sofa.

Версия decor включает подушки разного цвета как на фотографии стр. 102. **Версия luxury** включает однотонные подушки, обитые тканью/кожей того же цвета, что и диван.



P 64 Piede in metallo ottonato lucido
 Polished brass-plated metal legs
 Ножка - металл в отделке блестящая латунь

Nefele capitonné 3P Pag. 96

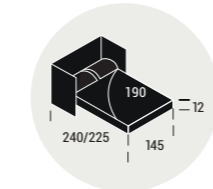
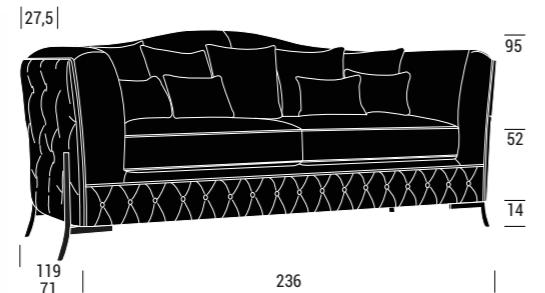

Nefele decor cuscini inclusi / included throw pillows / в комплекте с подушками

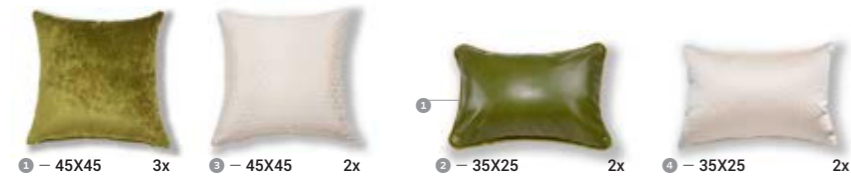

1 - 45X45 3x 2 - 45X45 2x 3 - 35X25 2x 4 - 35X25 2x

Rivestimento / Upholstery / Обивочная ткань
 1-Vegas Velvet Plain 1403/67
 2-Old/1
 3-Diamond Luxury/01
 4-Mirage Luxury/01

Lavorazione schienale interno liscio
 Lavorazione scocca esterna capitonné
 Plain inside backrest version
 Capitonné outer shell version
 Внутренняя обивка спинки - гладкая
 Внешняя обивка каркаса - каретная стяжка ("капитоне")

Nefele luxury cuscini inclusi / included throw pillows / в комплекте с подушками

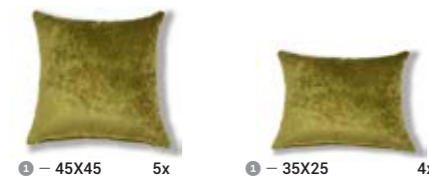

1 - 45X45 5x 2 - 35X25 4x

La **versione decor** include cuscini decorativi in diversi colori come foto pag. 96. La **versione luxury** include cuscini monocromatici rivestiti con il medesimo tessuto/pelle del divano.

The **decor version** includes throw pillows made of decorative fabrics, as on page 96. The **luxury version** includes solid colour throw pillows upholstered with the same fabric/leather used for the sofa.

Версия decor включает подушки разного цвета как на фотографии стр. 96. **Версия luxury** включает однотонные подушки, обитые тканью/кожей того же цвета, что и диван.



P 64 Piede in metallo ottonato lucido
 Polished brass-plated metal legs
 Ножка - металл в отделке блестящая латунь

Nefele Plain 4P Pag. 106

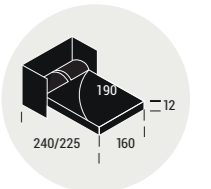
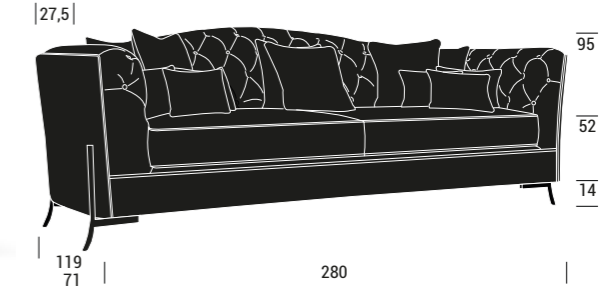

Nefele decor cuscini inclusi / included throw pillows / в комплекте с подушками



1 - 45X45 3x 2 - 45X45 3x 3 - 35X25 2x 4 - 35X25 4x

Rivestimento / Upholstery / Обивочная ткань
 1-G075/312
 2-Moon/619 Giallino
 3-Jungle Velvet 1638/05
 4-Candide/3200 12 67

Lavorazione schienale interno capitonné
 Lavorazione scocca esterna liscia
 Capitonné backrest Plain outer shell version
 Внутренняя отделка спинки - "капитоне"
 Внутренняя обивка спинки - гладкая

Nefele luxury cuscini inclusi / included throw pillows / в комплекте с подушками

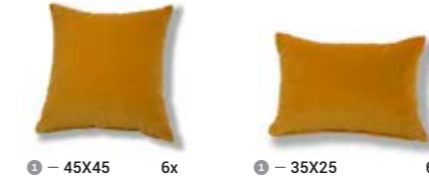

1 - 45X45 6x 2 - 35X25 6x

La **versione decor** include cuscini decorativi in diversi colori come foto pag. 106. La **versione luxury** include cuscini monocromatici rivestiti con il medesimo tessuto/pelle del divano.

The **decor version** includes throw pillows made of decorative fabrics, as on page 106. The **luxury version** includes solid colour throw pillows upholstered with the same fabric/leather used for the sofa.

Версия decor включает подушки разного цвета как на фотографии стр. 106. **Версия luxury** включает однотонные подушки, обитые тканью/кожей того же цвета, что и диван.



P 64 Piede in metallo ottonato lucido
 Polished brass-plated metal legs
 Ножка - металл в отделке блестящая латунь



Rouf
Roufs
Щуфы

119

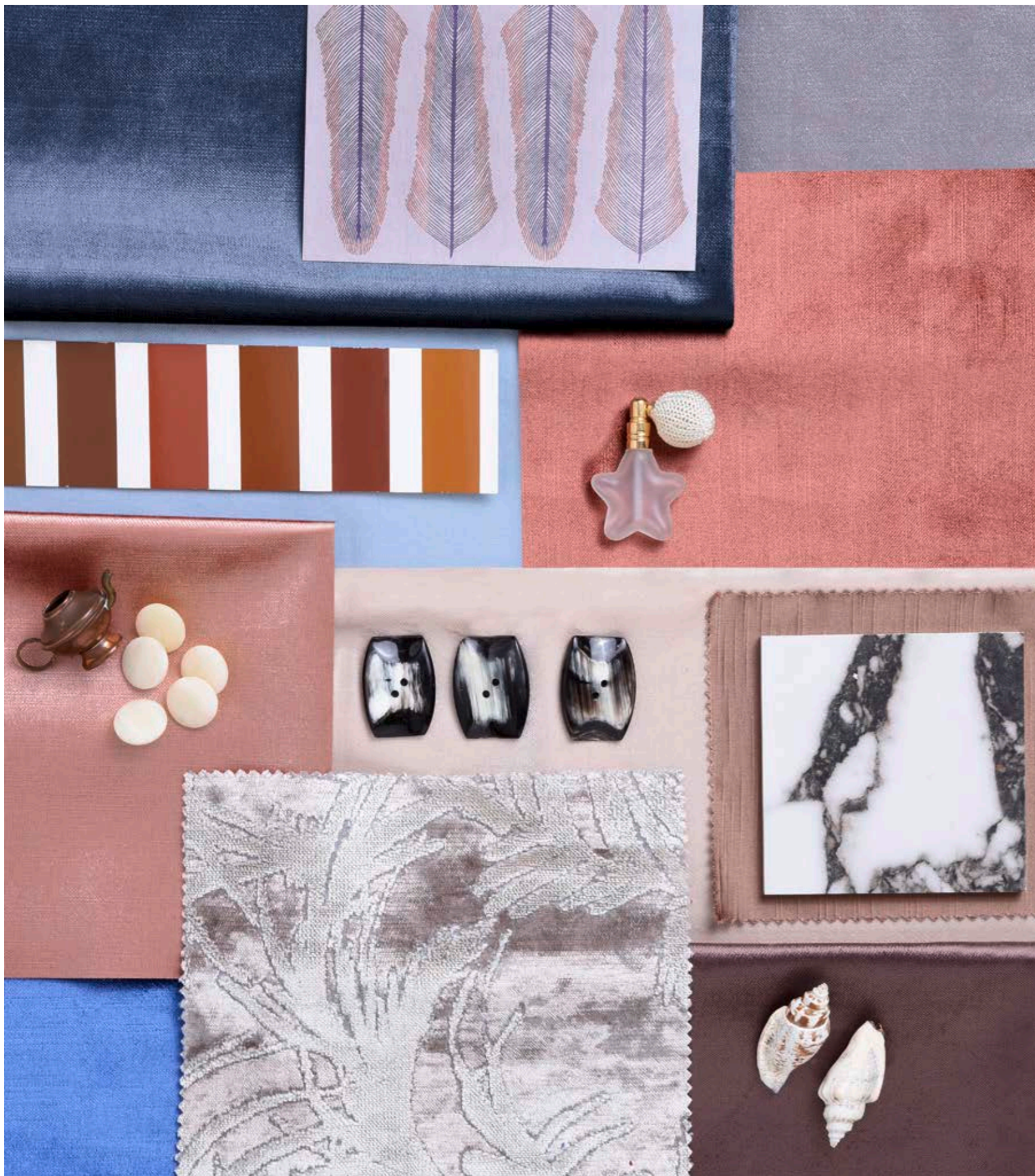

Un fiore grazioso, morbido, delicato e ricco di personalità, che spunta inaspettatamente in un giardino incantato con il preciso intento di riempirlo di grazia. Il pouf Arke è ispirato alla dea dell'arcobaleno, messaggera dei Titani.

A soft, delicate flower full of personality that unexpectedly sprouts in an enchanted garden with the precise intention of filling it with grace. The Arke pouf is inspired by the rainbow goddess, messenger of the Titans.

Изящный, мягкий, нежный и полный индивидуальности цветок, неожиданно появившийся в волшебном саду с явным намерением наполнить его грацией. Пуф Арке был вдохновлен богиней радуги, посланницей Титанов.



Arke





Pouf Poufs Пуфы
Domingo—Luxury

Arke



POUF
POUF
ПУФ
Sm D50xh40
Md D70xh40
Lg D100xh40
Bc 135x50xh40

**Finiture laminato / Laminate finishings /
Ламинированный деревянный цоколь**



Palette laminati
a pag. 202
Page 202 laminated
frame palette
Палитра отделок
ламината на стр. 202



Arke

Struttura in multistrato di abete in vari spessori, cl. E1 a bassa emissione di formaldeide. Imbottitura in poliuretano espanso indeformabile in densità da 30 a 40 kg/m³ e ovatta in poliester. Base in legno laminato in vari colori. Resine e collanti utilizzati sono privi di sostanze ozonolesive, CFC e solventi clorurati. Tutti i materiali impiegati rispettano la normativa EU 91/156 per lo smaltimento dei rifiuti. Prodotto lavorato interamente a mano in Italia. Il pouf Arke può essere rivestito con tutti i tessuti e le pelli delle collezioni tessili Domingo.

E1 fir plywood frame featuring low formaldehyde emission. 30 to 40 kg/m³ non-deformable polyurethane foam padding and polyester wadding. Laminated wood base (various colours available). The resins and adhesives we use are free of ozone-depleting substances, CFCs and chlorinated solvents. All the materials we use are in compliance with EU 91/156 regulations on waste disposal. Entirely handmade in Italy. The Arke pouf can be upholstered with any fabrics or leathers from the Domingo textile collections.

Структура - многослойная фанера из ели разной толщины класса E1 с низкой эмиссией формальдегида. Внутреннее наполнение - недеформируемый пенополиуретан плотностью от 30 до 40 кг/м³ и синтепон. Ламинированный деревянный цоколь может быть выполнен в различных цветах. Используемые типы смол и клеящих материалов не содержат озоноразрушающих веществ, хлорфторуглеродов и хлорсодержащих растворителей. Все материалы соответствуют требованиям EU 91/156 по утилизации отходов. Изделия ручной работы, полностью произведенные в Италии. Обивка пуфа Arke может быть выполнена из всех видов ткани и кожи коллекции Domingo.

Arke Sm

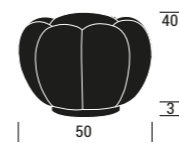

Rivestimento / Upholstery / Обивочная ткань
①-Brooklyn/07



Base in laminato 2007 vg CT
Laminate base 2007 vg CT
Цоколь: ламинат 2007 vg CT



Rivestimento / Upholstery / Обивочная ткань
①-Brooklyn/46



Base in laminato 2006 vg LUC
Laminate base 2006 vg LUC
Цоколь: ламинат 2006 vg LUC

Arke Md

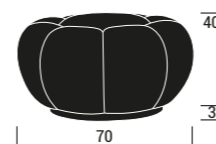

Rivestimento / Upholstery / Обивочная ткань
①-Brooklyn/41



Base in laminato 2006 vg LUC
Laminate base 2006 vg LUC
Цоколь: ламинат 2006 vg LUC



Rivestimento / Upholstery / Обивочная ткань
①-Brooklyn/13



Base in laminato 2007 vg CT
Laminate base 2007 vg CT
Цоколь: ламинат 2007 vg CT

Arke Lg

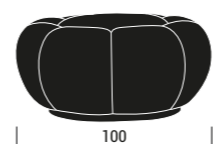

Rivestimento / Upholstery / Обивочная ткань
①-Brooklyn/24



Base in laminato 2007 vg CT
Laminate base 2007 vg CT
Цоколь: ламинат 2007 vg CT



Rivestimento / Upholstery / Обивочная ткань
①-Brooklyn/23



Base in laminato 2006 vg LUC
Laminate base 2006 vg LUC
Цоколь: ламинат 2006 vg LUC

Arke Bc

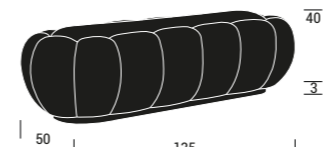

Rivestimento / Upholstery / Обивочная ткань
①-Brooklyn/20



Base in laminato 2008 vg SAT
Laminate base 2008 vg SAT
Цоколь: ламинат 2008 vg SAT



Rivestimento / Upholstery / Обивочная ткань
①-Brooklyn/33



Base in laminato 2000 vg SAT
Laminate base 2000 vg SAT
Цоколь: ламинат 2000 vg SAT

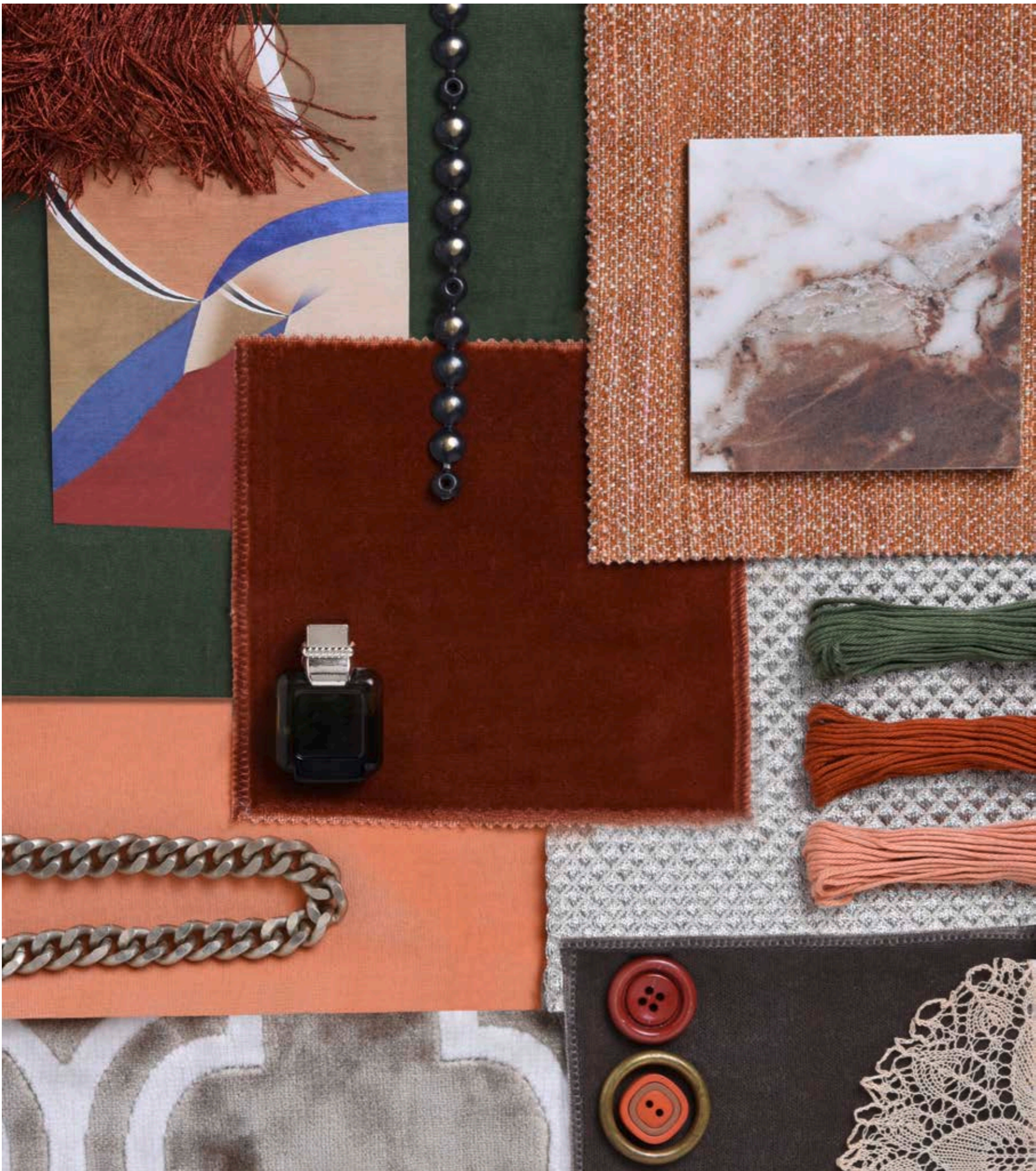

I pouf e le panchette Dione abbinati ai divani e alle poltrone dell'omonima collezione ispirata alla dea dell'amore, dell'acqua e del cielo luminoso, impreziosiscono l'ambiente connotandolo di una ricchezza semplice e irrinunciabile.

The Dione poufs and benches, combined with sofas and armchairs of the homonymous series inspired by the goddess of love, water and clear skies, embellish any living space with a simple and indispensable richness.

Пуфы и банкетки Dione в сочетании с диванами и креслами одноименной коллекции, вдохновленной богиней любви, дождя и ясного неба, украшают и обогащают интерьеры простым и незаменимым образом.



Dione





Pouf Poufs Пуфы
Domingo—Luxury

Dione

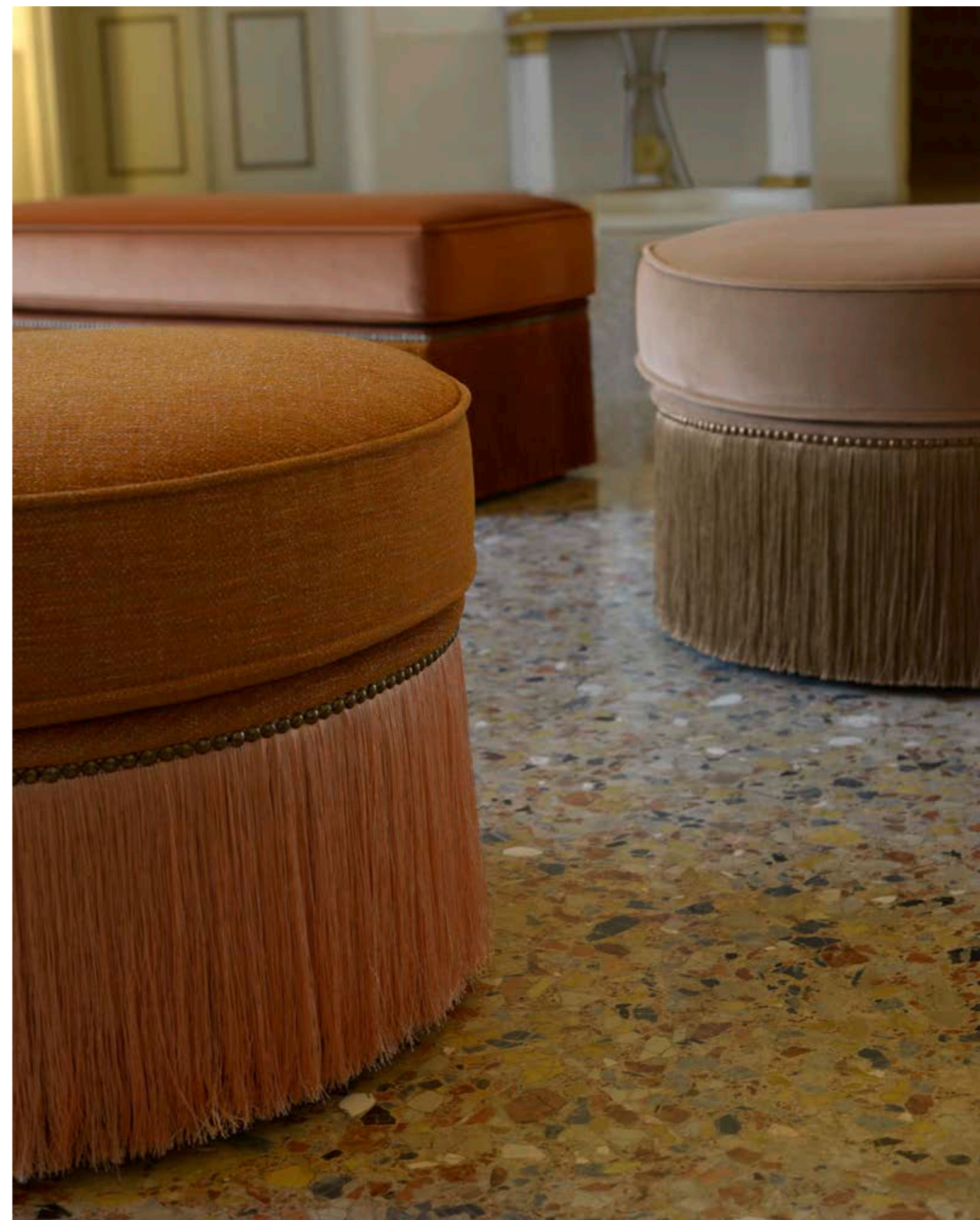

POUF
POUF
ПУФ

Sm D50xh45

Md D70xh45

Bc 120x45xh45

Dione

Struttura in multistrato di abete in vari spessori, cl. E1 a bassa emissione di formaldeide. Imbottitura in poliuretano espanso indeformabile in densità da 30 a 40 kg/m³ e ovatta in poliestere. Frangia in filato di organzino. Resine e collanti utilizzati sono privi di sostanze ozonolesive, CFC e solventi clorurati. Tutti i materiali impiegati rispettano la normativa EU 91/156 per lo smaltimento dei rifiuti. Prodotto lavorato interamente a mano in Italia. Il pouf Dione può essere rivestito con tutti i tessuti e le pelli delle collezioni tessili Domingo.

E1 fir plywood frame featuring low formaldehyde emission. 30 to 40 kg/m³ non-deformable polyurethane foam padding and polyester wadding. Organzine yarn fringe. The resins and adhesives we use are free of ozone-depleting substances, CFCs and chlorinated solvents. All the materials we use are in compliance with EU 91/156 regulations on waste disposal. Entirely handmade in Italy. The Dione pouf can be upholstered with any fabrics or leathers from the Domingo textile collections.

Struttura - многослойная фанера из ели разной толщины класса E1 с низкой эмиссией формальдегида. Внутреннее наполнение - недеформируемый пенополиуретан плотностью от 30 до 40 кг/м³ и синтепон. Бахрома - шелковая глянцевая пряжа. Используемые типы смол и клеящих материалов не содержат озоноразрушающих веществ, хлорфторуглеродов и хлорсодержащих растворителей. Все материалы соответствуют требованиям EU 91/156 по утилизации отходов. Изделия ручной работы, полностью произведенные в Италии. Обивка пуфа Dione может быть выполнена из всех видов ткани и кожи коллекции Domingo.

Dione Sm pouf

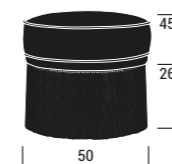

Rivestimento / Upholstery / Обивочная ткань
①-G075/102
②-Frangia fringe Бахрома h26/72R STD
Chiodini in oro invecchiato
Aged golden nails
Заклепки под состарившееся золото



Rivestimento / Upholstery / Обивочная ткань
①-G075/102
②-Frangia fringe Бахрома h26/29R STD
Chiodini in oro invecchiato
Aged golden nails
Заклепки под состарившееся золото



Dione Md pouf

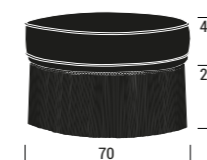

Rivestimento / Upholstery / Обивочная ткань
①-G075/208
②-Frangia fringe Бахромаh26/254R STD
Chiodini in oro invecchiato
Aged golden nails
Заклепки под состарившееся золото



Rivestimento / Upholstery / Обивочная ткань
①-80723 Crusca/46 Rame rosato
②-Frangia fringe Бахрома h26/79R OPT
Chiodini in oro invecchiato
Aged golden nails
Заклепки под состарившееся золото



Dione Bc bench

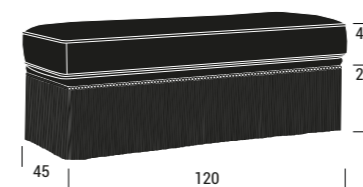

Rivestimento / Upholstery / Обивочная ткань
①-G075/456
②-Frangia fringe Бахрома h26/79R OPT
Chiodini in oro invecchiato
Aged golden nails
Заклепки под состарившееся золото



Rivestimento / Upholstery / Обивочная ткань
①-8336/15
②-Frangia fringe Бахрома h26/29R STD
Chiodini in oro invecchiato
Aged golden nails
Заклепки под состарившееся золото



Frangia / Fringe / Бахрома / h26 cm

STD = colori di serie / standard colours / стандартные цвета
 OPT = colori optional / optional colours / по желанию
 (за дополнительную оплату)

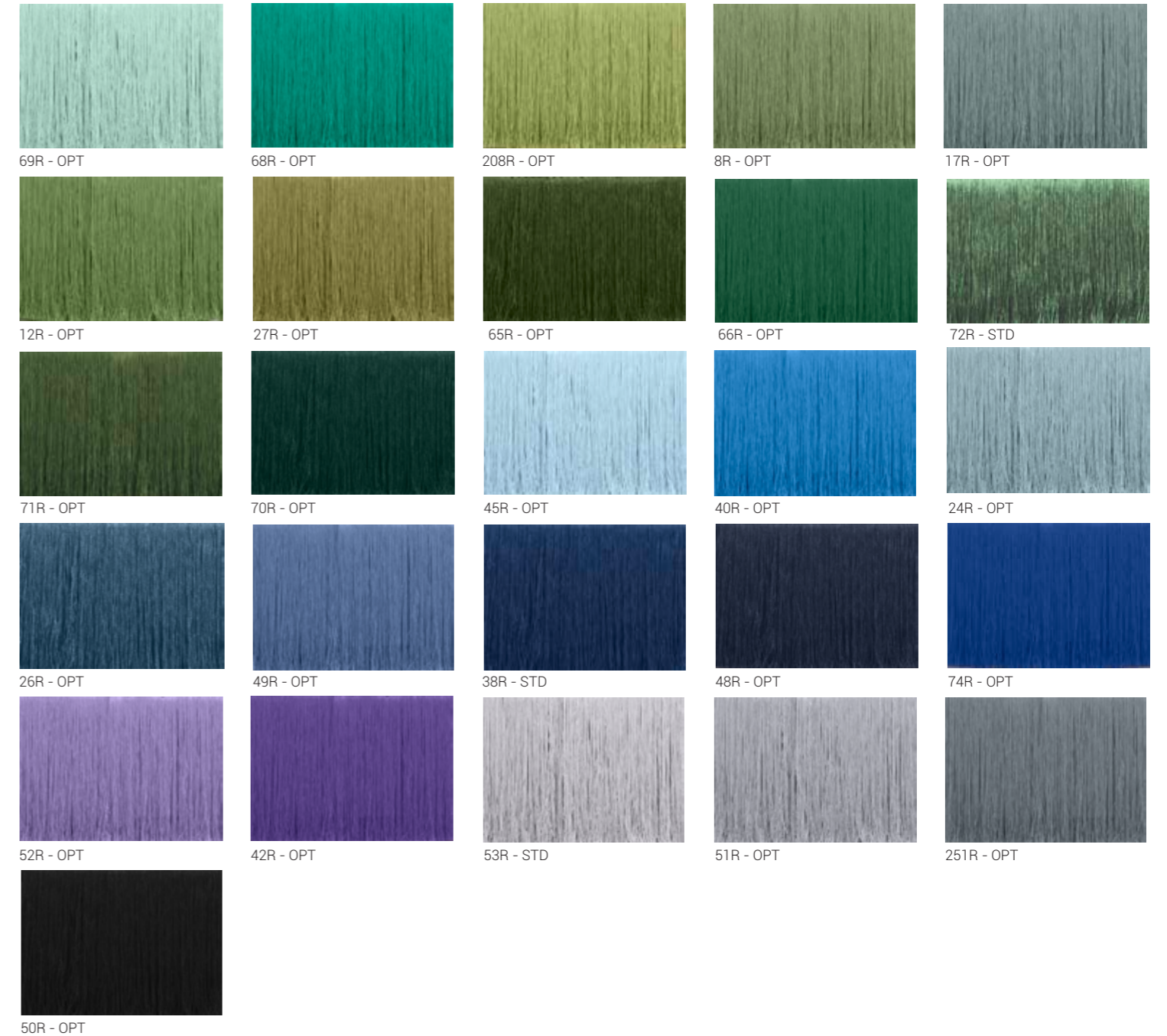

Chiodini metallici / Metal nails / Металлические заклепки



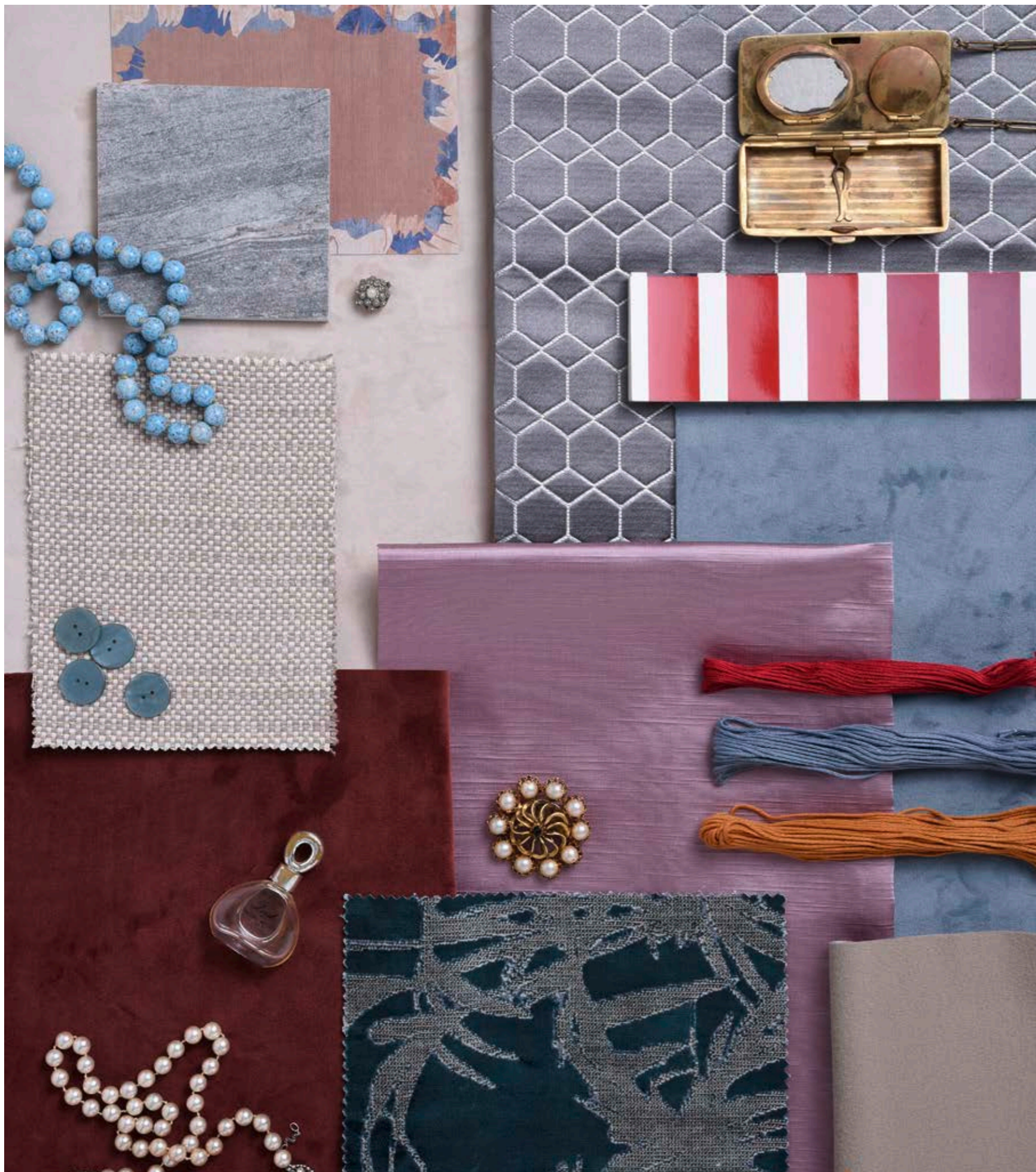

Geometrie primarie e rigore formale Eos, una linea di pouf che completano l'ambiente con spirito minimalista, ispirati alla divinità dell'alba, la dea dalle "rose dita" citata da Omero.

Primary geometries and formal rigor for Eos, a series of poufs that complete the spaces they occupy with a minimalist spirit, inspired by the rosy-fingered goddess of dawn mentioned by Homer.

Основные геометрические формы и формальная строгость для пуфов Eos, которые дополняют оформление интерьера в минималистском стиле и относят нас к богине утренней зари, упоминаемой Гомером как богиня с «розовыми перстами».



Eos





Pouf Poufs Пуфы
Domingo—Luxury

Eos

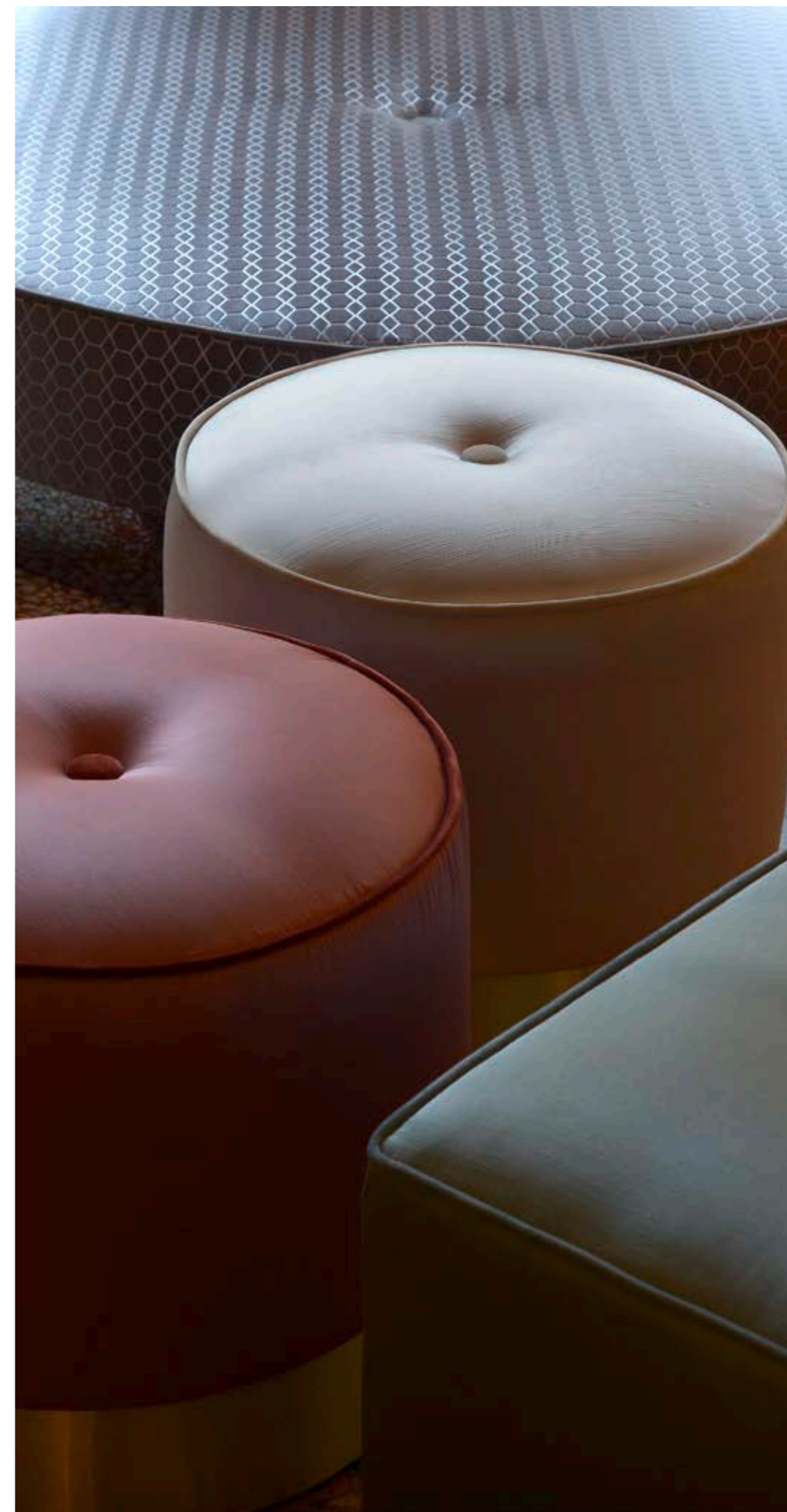

POUF
POUF
ПУФ
Rs D45xh42
Sm 45x45xh42
Rb D120xh30

**Finiture laminato / Laminate finishings /
Ламинированный деревянный цоколь**



Palette laminati
a pag. 202
Page 202 laminated
frame palette
Палитра отделок
ламината на стр. 202



Eos

Struttura in multistrato di abete in vari spessori, cl. E1 a bassa emissione di formaldeide. Imbottitura in poliuretano espanso indeformabile in densità da 30 a 40 kg/m³ e ovatta in poliestere. Base in legno laminato in vari colori. Resine e collanti utilizzati sono privi di sostanze ozonolesive, CFC e solventi clorurati. Tutti i materiali impiegati rispettano la normativa EU 91/156 per lo smaltimento dei rifiuti. Prodotto lavorato interamente a mano in Italia. Il pouf Eos può essere rivestito con tutti i tessuti e le pelli delle collezioni tessili Domingo.

E1 fir plywood frame (thickness varies) featuring low formaldehyde emission. 30 to 40 kg/m³ non-deformable polyurethane foam padding and polyester wadding. Laminated wood base (various colours available). The resins and adhesives we use are free of ozone-depleting substances, CFCs and chlorinated solvents. All the materials we use are in compliance with EU 91/156 regulations on waste disposal. Entirely handmade in Italy. The Eos pouf can be upholstered with any fabrics or leathers from the Domingo textile collections.

Структура - многослойная фанера из ели разной толщины класса E1 с низкой эмиссией формальдегида. Внутреннее наполнение - недеформируемый пенополиуретан плотностью от 30 до 40 кг/м³ и синтепон. Ламинированный деревянный цоколь может быть выполнен в различных цветах. Используемые типы смол и клеящих материалов не содержат озоноразрушающих веществ, хлорфторуглеродов и хлорсодержащих растворителей. Все материалы соответствуют требованиям EU 91/156 по утилизации отходов. Изделия ручной работы, полностью произведенные в Италии. Обивка пуфа Eos может быть выполнена из всех видов ткани и кожи коллекции Domingo.

Eos Rs

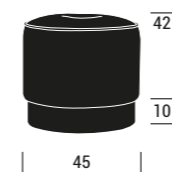

Eos Sm

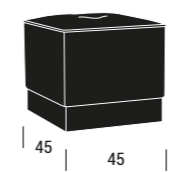

Eos Rb

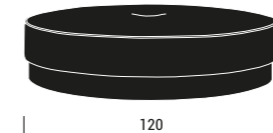

Rivestimento / Upholstery / Обивочная ткань
 ①-Java Heather F0496/20
 ②-Bottone e filetto 8336/6
 Button and piping 8336/6
 Пуговица и кант: 8336/6



Base in laminato 2003 vg SAT
Laminate base 2003 vg SAT
Цоколь: ламинат 2003 vg SAT



Rivestimento / Upholstery / Обивочная ткань
 ①-Java Dove F0496/10
 ②-Bottone e filetto 8336/51
 Button and piping 8336/51
 Пуговица и кант: 8336/51



Base in laminato 2003 vg SAT
Laminate base 2003 vg SAT
Цоколь: ламинат 2003 vg SAT



Rivestimento / Upholstery / Обивочная ткань
 ①-Kauai Mocha F1299/07
 ②-Bottone 8336/51
 Button 8336/51
 Пуговица: 8336/51



Base in laminato 2003 vg SAT
Laminate base 2003 vg SAT
Цоколь: ламинат 2003 vg SAT



Rivestimento / Upholstery / Обивочная ткань
 ①-Java Eau de Nil F0496/14
 ②-Bottone e filetto 8336/55
 Button and piping 8336/55
 Пуговица и кант: 8336/55



Base in laminato 2003 vg SAT
Laminate base 2003 vg SAT
Цоколь: ламинат 2003 vg SAT



Rivestimento / Upholstery / Обивочная ткань
 ①-Candide/3200 12 67
 ②-Bottone e filetto 8336/5
 Button and piping 8336/5
 Пуговица и кант 8336/5



Base in laminato 2007 vg CT
Laminate base 2007 vg CT
Цоколь: ламинат 2007 vg CT

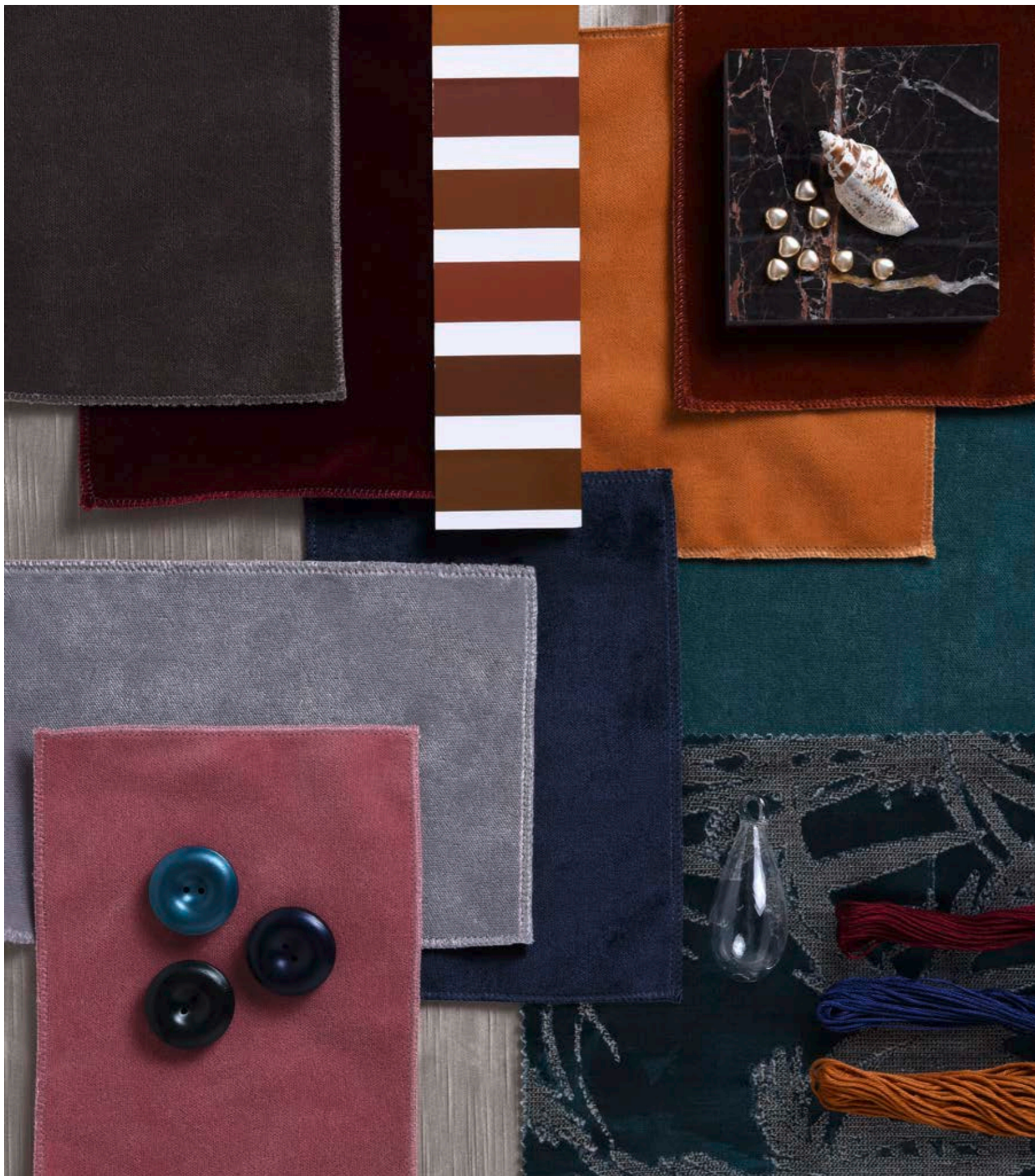

Semplice, elegante e cromaticamente mutevole, il pouf Chione, ispirato alla dea della bellezza, si inserisce silenzioso in qualsiasi ambiente alla ricerca di elementi complementari ma non invadenti.

Understated, elegant and chromatically changeable, the Chione pouf is inspired by the goddess of beauty, and fits quietly wherever complementary but non intrusive elements are needed.

Простой, элегантный и "цветоизменяемый" пуф Chione, посвященный богине красоты - Хионе, бесшумно вписывается в любой интерьер в поисках комплектующих ненавязчивых элементов.



Chione





Pouf Poufs Пуфы
Domingo—Luxury

Chione



POUF
POUF
ПУФ

D40xh44

Finiture laminato / Laminate finishings / Ламинированный деревянный цоколь



Palette laminati
a pag. 202
Page 202 laminated
frame palette
Палитра отделки
ламината на стр. 202



Chione

Struttura in multistrato di abete in vari spessori, cl. E1 a bassa emissione di formaldeide. Imbottitura in poliuretano espanso indeformabile in densità da 30 a 40 kg/m³ e ovatta in poliester. Base in legno laminato in vari colori. Resine e collanti utilizzati sono privi di sostanze ozonolesive, CFC e solventi clorurati. Tutti i materiali impiegati rispettano la normativa EU 91/156 per lo smaltimento dei rifiuti. Prodotto lavorato interamente a mano in Italia. Il pouf Chione può essere rivestito con tutti i tessuti e le pelli delle collezioni tessili Domingo.

E1 fir plywood frame (thickness varies) featuring low formaldehyde emission. 30 to 40 kg/m³ non-deformable polyurethane foam padding and polyester wadding. Laminated wood base (various colours available). The resins and adhesives we use are free of ozone-depleting substances, CFCs and chlorinated solvents. All the materials we use are in compliance with EU 91/156 regulations on waste disposal. Entirely handmade in Italy. The Chione pouf can be upholstered with any fabrics or leathers from the Domingo textile collections.

Структура - многослойная фанера из ели разной толщины класса E1 с низкой эмиссией формальдегида. Внутреннее наполнение - недеформируемый пенополиуретан плотностью от 30 до 40 кг/м³ и синтепон. Ламинированный деревянный цоколь может быть выполнен в различных цветах. Используемые типы смол и клеящих материалов не содержат озоноразрушающих веществ, хлорфторуглеродов и хлорсодержащих растворителей. Все материалы соответствуют требованиям EU 91/156 по утилизации отходов. Изделия ручной работы, полностью произведенные в Италии. Обивка пуфа Chione может быть выполнена из всех видов ткани и кожи коллекции Domingo.

Chione

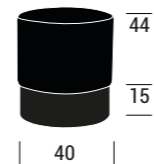

Rivestimento /
Upholstery /
Обивочная ткань
①-8336/11



Base in laminato 2000 vg SAT
Laminate base 2000 vg SAT
Цоколь: ламинат 2000 vg SAT



Rivestimento /
Upholstery /
Обивочная ткань
①-8336/5



Base in laminato 2000 vg SAT
Laminate base 2000 vg SAT
Цоколь: ламинат 2000 vg SAT



Rivestimento /
Upholstery /
Обивочная ткань
①-8336/40



Base in laminato 2012 vg SAT
Laminate base 2012 vg SAT
Цоколь: ламинат 2012 vg SAT



Rivestimento /
Upholstery /
Обивочная ткань
①-8336/57



Base in laminato 2012 vg SAT
Laminate base 2012 vg SAT
Цоколь: ламинат 2012 vg SAT



Rivestimento /
Upholstery /
Обивочная ткань
①-8336/15



Base in laminato 2007 vg CT
Laminate base 2007 vg CT
Цоколь: ламинат 2007 vg CT



Rivestimento /
Upholstery /
Обивочная ткань
①-8336/5



Base in laminato 2007 vg CT
Laminate base 2007 vg CT
Цоколь: ламинат 2007 vg CT



Rivestimento /
Upholstery /
Обивочная ткань
①-8336/29



Base in laminato 2006 vg LUC
Laminate base 2006 vg LUC
Цоколь: ламинат 2006 vg LUC



Rivestimento /
Upholstery /
Обивочная ткань
①-8336/3



Base in laminato 2003 vg SAT
Laminate base 2003 vg SAT
Цоколь: ламинат 2003 vg SAT



Rivestimento /
Upholstery /
Обивочная ткань
①-8336/5



Base in laminato 2003 vg SAT
Laminate base 2003 vg SAT
Цоколь: ламинат 2003 vg SAT



Rivestimento /
Upholstery /
Обивочная ткань
①-8336/53



Base in laminato 2003 vg SAT
Laminate base 2003 vg SAT
Цоколь: ламинат 2003 vg SAT



Rivestimento /
Upholstery /
Обивочная ткань
①-8336/15



Base in laminato 2003 vg SAT
Laminate base 2003 vg SAT
Цоколь: ламинат 2003 vg SAT



Rivestimento /
Upholstery /
Обивочная ткань
①-8336/27



Base in laminato 2008 vg SAT
Laminate base 2008 vg SAT
Цоколь: ламинат 2008 vg SAT



Rivestimento /
Upholstery /
Обивочная ткань
①-8336/40



Base in laminato 2008 vg SAT
Laminate base 2008 vg SAT
Цоколь: ламинат 2008 vg SAT



Sofisticato, morbido ed
ammiccante, il pouf Tara trae
ispirazione dalle Esperidi, le
ninfe della sera e della luce del
tramonto.

Sophisticated, soft and
allusive, the Tara pouf
draws inspiration from
the Hesperides, the nymphs
of the evening and of the
golden light of sunsets.

Изысканный, мягкий
и привлекательный
пуф Tara воплощает
Гесперид - нимф заката и
заходящего солнца.



Tara





Pouf Poufs Пуфы
Domingo—Luxury

Tara

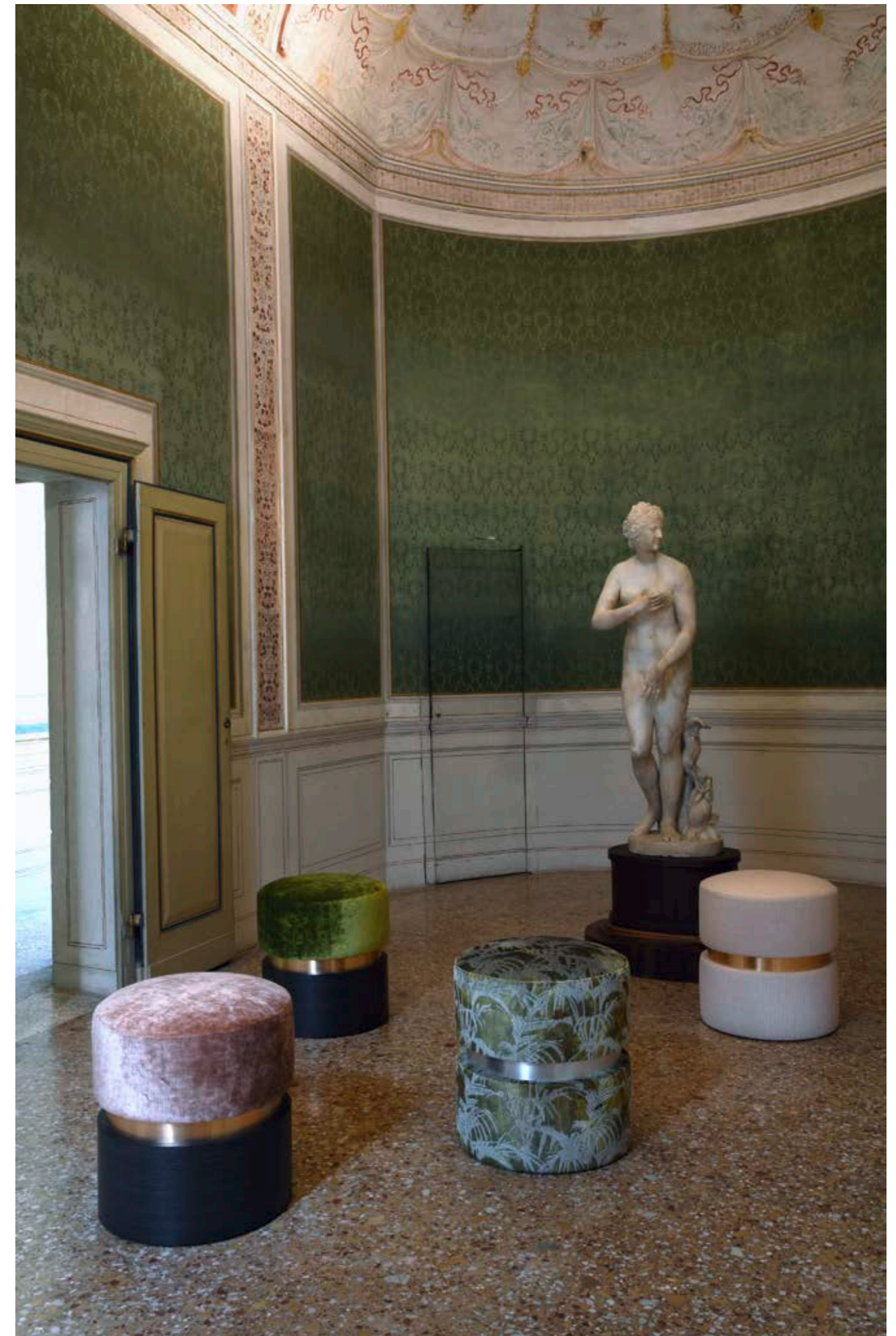

POUF
POUF
ПУФ

D50xh45

Finiture laminato / Laminate finishings / Ламинированный деревянный цоколь



Palette laminati
a pag. 202
Page 202 laminated
frame palette
Палитра отделки
ламината на стр. 202



Tara

Struttura in multistrato di abete in vari spessori, cl. E1 a bassa emissione di formaldeide. Imbottitura in poliuretano espanso indeformabile in densità da 30 a 40 kg/m³ e ovatta in poliestere. Base e fascia in laminato in vari colori. Resine e collanti utilizzati sono privi di sostanze ozonolesive, CFC e solventi clorurati. Tutti i materiali impiegati rispettano la normativa EU 91/156 per lo smaltimento dei rifiuti. Prodotto lavorato interamente a mano in Italia. Il pouf Tara è disponibile interamente rivestito in tessuto o con base in legno laminato.

E1 fir plywood frame featuring low formaldehyde emission. 30 to 40 kg/m³ non-deformable polyurethane foam padding and polyester wadding. Laminated wood base (various colours available). The resins and adhesives we use are free of ozone-depleting substances, CFCs and chlorinated solvents. All the materials we use are in compliance with EU 91/156 regulations on waste disposal. Entirely handmade in Italy. The Tara pouf can be completely upholstered with fabric; alternatively it can feature a laminated wood base

Структура - многослойная фанера из ели разной толщины класса E1 с низкой эмиссией формальдегида. Внутреннее наполнение - недеформируемый пенополиуретан плотностью от 30 до 40 кг/м³ и синтепон. Цоколь и центральная вставка - ламинат в различных цветах. Используемые типы смол и клеящих материалов не содержат озоноразрушающих веществ, хлорфторуглеродов и хлорсодержащих растворителей. Все материалы соответствуют требованиям EU 91/156 по утилизации отходов. Изделия ручной работы, полностью произведенные в Италии. Пуф Tara предлагается в двух вариантах: полностью в ткани или с ламинированным деревянным цоколем.

Tara tex

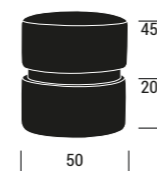

Tara mix

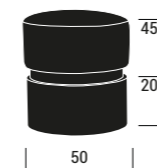

Rivestimento /
Upholstery /
Обивочная ткань
①-Kauai Blush
F1299/01



Anello in laminato 2008 vg SAT
Laminate ring 2008 vg SAT
Вставка: ламинат 2008 vg SAT



Rivestimento /
Upholstery /
Обивочная ткань
①-Exotica Tropicale
F1305/02 Citron



Anello in laminato 2000 vg SAT
Laminate ring 2000 vg SAT
Вставка: ламинат 2000 vg SAT



Rivestimento /
Upholstery /
Обивочная ткань
①-Vegas Velvet Plain
1403/67



Anello in laminato 2008 vg SAT
Laminate ring 2008 vg SAT
Вставка: ламинат 2008 vg SAT



Rivestimento /
Upholstery /
Обивочная ткань
①-Vegas Velvet Plain
1403/83



Anello in laminato 2008 vg SAT
Laminate ring 2008 vg SAT
Вставка: ламинат 2008 vg SAT

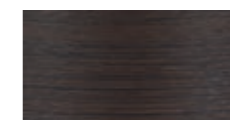

Base in laminato 4485 GHI
Laminate base 4485 GHI
Цоколь: ламинат 4485 GHI



Base in laminato 4485 GHI
Laminate base 4485 GHI
Цоколь: ламинат 4485 GHI



Tavoli
Tables
СТОЛИКИ

173

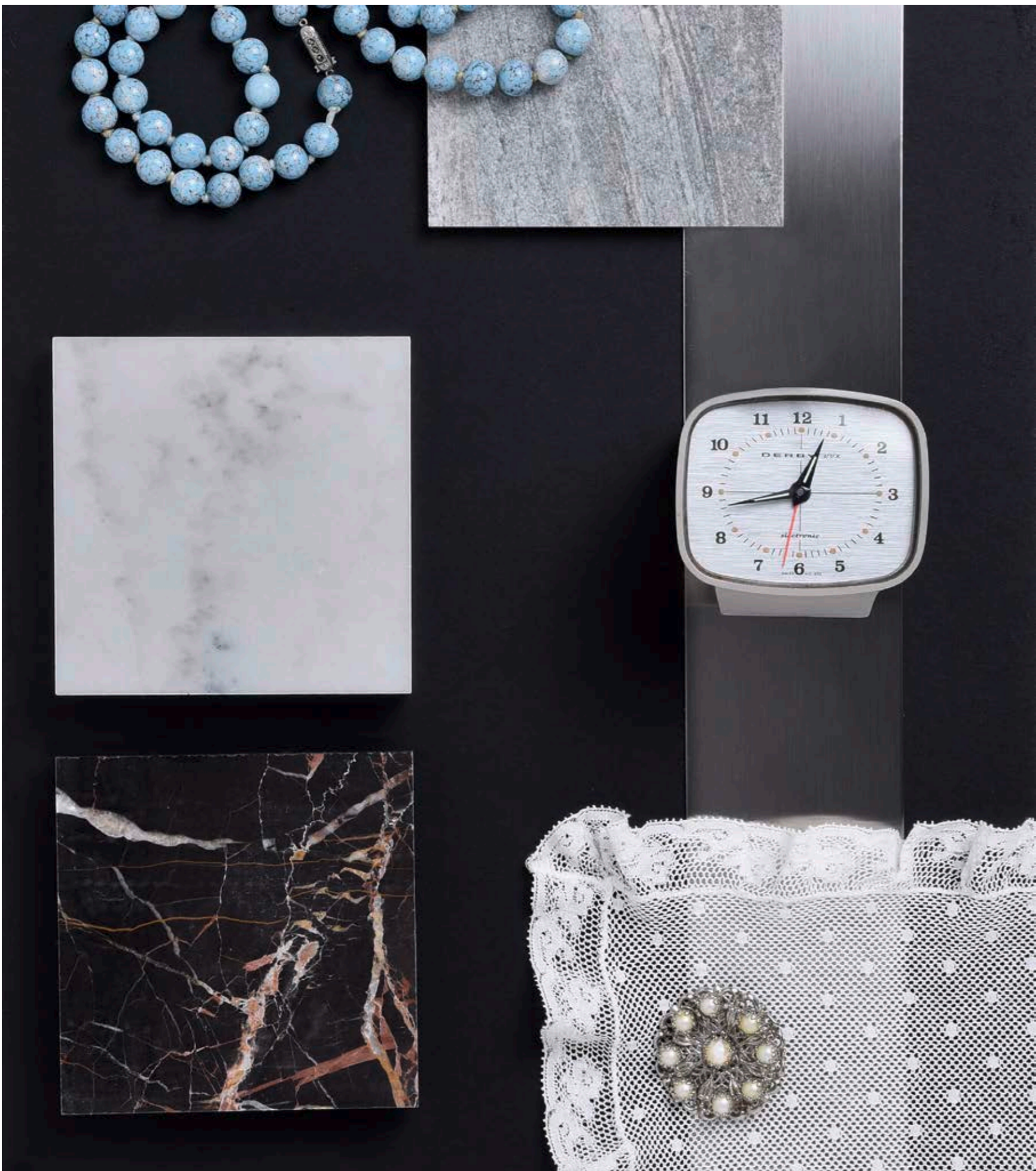

Forme morbide e giochi di ombre circolari per la collezione Febe, ispirata alla figura mitologica della omonima titanide, figlia di Urano e nonna di Artemide, tradizionalmente associata alla luna.

Soft shapes and circular shadows for the Febe series, which draws its inspiration from the homonymous titanide traditionally associated with the Moon, daughter of Uranus and grandmother of Artemis.

Мягкие формы и игра круглых теней характеризуют коллекцию Febe, посвященную одноименному мифологическому персонажу - титаниде, дочери Урана и бабушке Артемиды, которую традиционно связывают с луной.



Febe





Tavoli Tables Столики
Domingo—Luxury

Febe

TAVOLO TABLE СТОЛИК	POUF POUF ПУФ
Sm D40xh57	D80xh24
Md D55xh40	

Finiture tavoli / Tables finishings / Отделки столиков



Palette strutture metallo e piani ceramica a pag. 202
Page 202 metal frame palette and ceramic tops
Палитра отделок металлических структур и керамических столешниц на стр. 202

Febe

Struttura in metallo.

Finiture: versione ottone brunito verniciata a polveri, versioni ottone lucido e canna di fucile trattate con finitura galvanica e protezione trasparente. Piano in ceramica effetto marmo, spessore 0,6 cm ottenuto tramite cottura, spazzolatura e lucidatura meccanica. Superficie lucida, riflettente e antimacchia.

Metal frame.

Finishes: the burnished brass version features a powder-coated finish; the polished brass and gunmetal versions feature a galvanised finish with transparent protection. 0.6 cm-thick ceramic top with marble finish obtained by firing, brushing and mechanical polishing. Polished, reflective and stain-resistant surface.

Структура - металл.

Виды отделки: покраска в цвет полированной воронёной латуни; глянцевая латунь и canna di fucile (гальваника с прозрачным защитным покрытием). Столешница - керамика с эффектом мрамора, толщина 0,6 см, изготовлена посредством обжига, щеточной зачистки и механической полировки. Поверхность - глянцевая, отражающая и пятноустойчивая.

Febe Sm tavolino



Finitura in canna di fucile lucido
Polished gunmetal finishing
Отделка: canna di fucile блестящая



Piano in ceramica effetto marmo Breccia
Marble finish ceramic top Breccia
Столешница: керамика с эффектом мрамора Breccia



Finitura in ottone lucido
Polished brass finishing
Отделка: глянцевая латунь



Piano in ceramica effetto marmo Onice Bamboo
Marble finish ceramic top Onice Bamboo
Столешница: керамика с эффектом мрамора Onice Bamboo



Finitura in ottone brunito satinato
Satin burnished brass finishing
Отделка: полированная воронёная латунь



Piano in ceramica effetto marmo Onice Bamboo
Marble finish ceramic top Onice Bamboo
Столешница: керамика с эффектом мрамора Onice Bamboo



Finitura in ottone brunito satinato
Satin burnished brass finishing
Отделка: полированная воронёная латунь

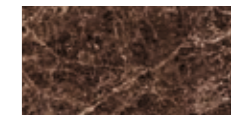

Piano in ceramica effetto marmo Emperador
Marble finish ceramic top Emperador
Столешница: керамика с эффектом мрамора Emperador

Febe Md tavolino

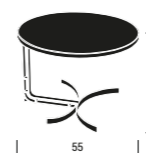

Finitura in canna di fucile lucido
Polished gunmetal finishing
Отделка: canna di fucile блестящая

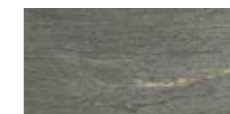

Piano in ceramica effetto marmo Majestic Marble 03
Marble finish ceramic top Majestic Marble 03
Столешница: керамика с эффектом мрамора Majestic Marble 03

Febe pouf

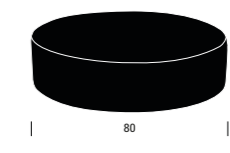

Rivestimento / Upholstery / Обивочная ткань
①-8336/55



Rivestimento / Upholstery / Обивочная ткань
①-Art.1469/60



Rivestimento / Upholstery / Обивочная ткань
①-G075/234



Stilizzato, minimalista e impettito, il tavolo Ceo si ispira al titano portatore di intelligenza, il dio che incarna l'asse celeste attorno al quale ruota l'universo.

Stylised, minimalist and upright, the Ceo coffee table is inspired by the bearer of intelligence, the Titan God who embodies the celestial axis around which the heavens revolve.

Стилизованный, минималистский и горделиво смотрящийся столик Ceo напоминает нам о титане Кеосе, воплошающем разум и небесную ось, вокруг которой вращаются созвездия.



Ceo



Tavoli Tables Столики
Domingo—Luxury

Ceo



TAVOLO TABLE СТОЛИК
Sm D40xh63
Md D50xh43
Lg D60xh33

Finiture tavoli / Tables finishings / Отделки столиков



Palette strutture metallo e piani marmo a pag. 202
Page 202 metal frame palette and marble tops
Палитра отделок металлических структур и мраморных столешниц на стр. 202



Ceo

Struttura in metallo.

Finiture: versione ottone brunito verniciata a polveri, versioni ottone lucido e canna di fucile trattate con finitura galvanica e protezione trasparente. Piano in marmo naturale protetto con antimacchia, spessore 2 cm.

Metal frame.

Finishes: the burnished brass version features a powder-coated finish; the polished brass and gunmetal versions feature a galvanised finish with transparent protection. Stain-resistant, 2 cm-thick natural marble top.

Структура - металл.

Виды отделки: покраска в цвет полированной воронёной латуни; глянцевая латунь и canna di fucile (гальваника с прозрачным защитным покрытием). Столешница из натурального мрамора с пятноустойчивым покрытием, толщина - 2 см.

Ceo Sm



Finitura in ottone lucido
Polished brass finishing
Отделка: глянцевая латунь



Piano in marmo Moresco Imperiale
Marble top Moresco Imperiale
Столешница: мрамор Moresco Imperiale



Finitura in ottone brunito satinato
Satin burnished brass finishing
Отделка: полированная воронёная латунь

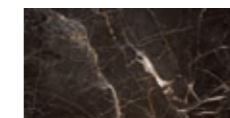

Piano in marmo Noir Saint Laurent
Marble top Noir Saint Laurent
Столешница: мрамор Noir Saint Laurent



Finitura in ottone brunito satinato
Satin burnished brass finishing
Отделка: полированная воронёная латунь



Piano in marmo Bianco Calacatta
Marble top White Calacatta
Столешница: мрамор Bianco Calacatta



Finitura in canna di fucile lucido
Polished gunmetal finishing
Отделка: canna di fucile глянцевая



Piano in marmo Bianco Calacatta
Marble top White Calacatta
Столешница: мрамор Bianco Calacatta

Ceo Md



Finitura in ottone brunito satinato
Satin burnished brass finishing
Структура: полированная воронёная латунь

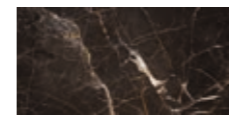

Piano in marmo Noir Saint Laurent
Marble top Noir Saint Laurent
Столешница: мрамор Noir Saint Laurent

Ceo Lg



Finitura in ottone brunito satinato
Satin burnished brass finishing
Структура: полированная воронёная латунь

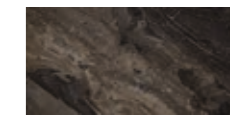

Piano in marmo Cappuccino
Marble top Cappuccino
Столешница: мрамор Cappuccino

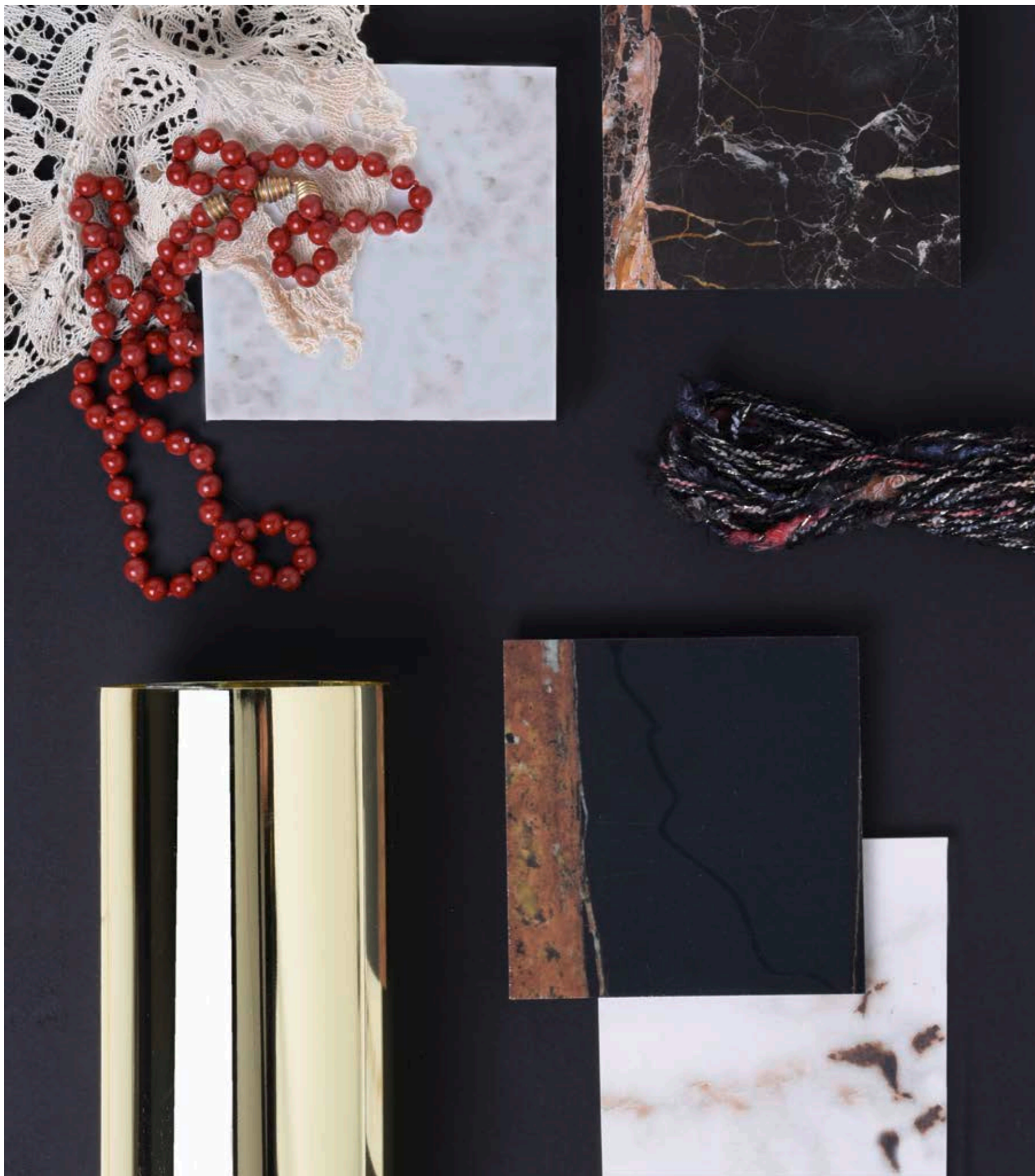

Cerchi concentrici che vivono a sé stanti o si incrociano e finiture che sfumano in colori indefiniti ispirati a Teti, la ninfa più belle delle Nereidi, dea dei mari e della metamorfosi.

Concentric circles that stand alone or overlap and finishes that fade into indefinite hues define Teti, the series that bears the name of the most beautiful nymph among the Nereids, goddess of waters and metamorphosis.

Концентрические круги, пересекающиеся или живущие сами по себе, и отделка, растворяющаяся в неопределенных тонах, навевают мысль о Teti, самой красивой нимфы из nereid, богиня морей и метаморфоза.



Teti



Tavoli Tables Столики
Domingo—Luxury

Teti

TAVOLO TABLE СТОЛИК
Sm 42xh63
Md 52xh43
Lg 79.5xh32

Finiture tavoli / Tables finishings / Отделки столиков



Palette strutture metallo e piani ceramica a pag. 202
Page 202 metal frame palette and ceramic tops
Палитра отделок металлических структур и керамических столешниц на стр. 202



Teti

Struttura in metallo.

Finiture: versione ottone brunito verniciata a polveri, versioni ottone lucido e canna di fucile trattate con finitura galvanica e protezione trasparente. Piano in ceramica effetto marmo, spessore 0,6 cm ottenuto tramite cottura, spazzolatura e lucidatura meccanica. Superficie lucida, riflettente e antimacchia.

Metal frame.

Finishes: the burnished brass version features a powder-coated finish; the polished brass and gunmetal versions feature a galvanised finish with transparent protection. 0.6 cm-thick ceramic top with marble finish obtained by firing, brushing and mechanical polishing. Polished, reflective and stain-resistant surface.

Каркас - металл.

Виды отделки: покраска в цвет полированной воронёной латуни; глянцевая латунь и canna di fucile (гальваника с прозрачным защитным покрытием). Столешница - керамика с эффектом мрамора, толщина 0,6 см, изготовлена посредством обжига, шеточной зачистки и механической полировки. Поверхность - глянцевая, отражающая и пятноустойчивая.

Teti Sm



Finitura in ottone brunito satinato
Satin burnished brass finishing
Отделка: полированная воронёная латунь



Piano in ceramica effetto marmo Onice Bamboo
Marble finish ceramic top Onice Bamboo
Столешница: керамика с эффектом мрамора Onice Bamboo



Finitura in canna di fucile lucido
Polished gunmetal finishing
Отделка: canna di fucile глянцевая

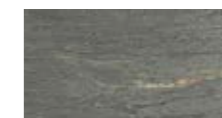

Piano in ceramica effetto marmo Majestic Marble 03
Marble finish ceramic top Majestic Marble 03
Столешница: керамика с эффектом мрамора Majestic Marble 03



Finitura in ottone lucido
Polished brass finishing
Отделка: глянцевая латунь

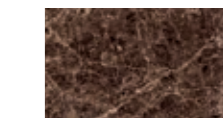

Piano in ceramica effetto marmo Emperor
Marble finish ceramic top Emperor
Столешница: керамика с эффектом мрамора Emperor

Teti Md

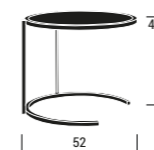

Finitura in ottone lucido
Polished brass finishing
Отделка: глянцевая латунь



Piano in ceramica effetto marmo Sahara Noir
Marble finish ceramic top Sahara Noir
Столешница: керамика с эффектом мрамора Sahara Noir

Teti Lg

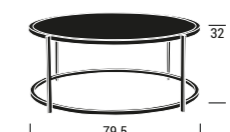

Finitura in ottone lucido
Polished brass finishing
Отделка: глянцевая латунь



Piano in ceramica effetto marmo Emperor
Marble finish ceramic top Emperor
Столешница: керамика с эффектом мрамора Emperor



Geometrie scomposte creano interessanti effetti ottici che movimentano la regolarità delle forme squadrate di Rea, una collezione ispirata all'antica dea della terra, titanide e madre di Zeus.

Decomposed geometries create interesting optical effects that enliven the regularity of the square shapes of Rea, a series inspired by the ancient Titan goddess of the Earth, Zeus' mother.

Разнообразные геометрические мотивы создают интересный оптический эффект, который оживляет регулярность квадратных и прямоугольных форм коллекции Rea, посвященной древней богине земли, титаниде и матери Зевса.



Rea



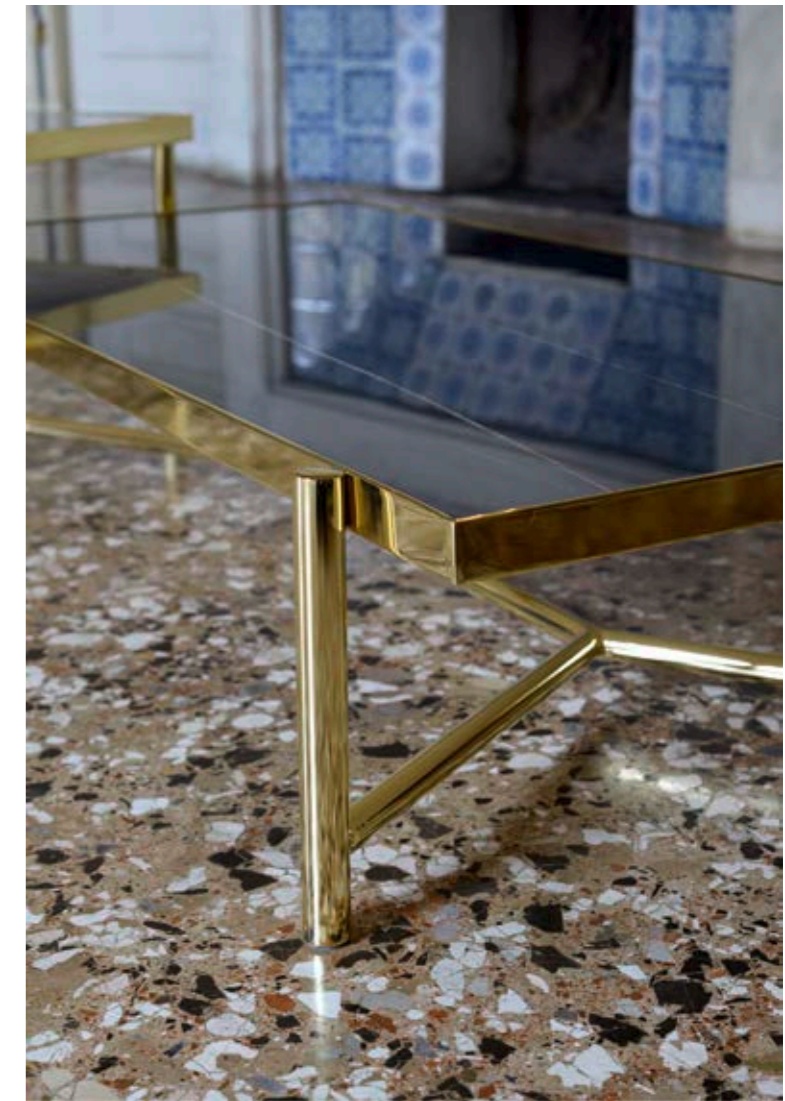

Tavoli Tables Столики
Domingo—Luxury

Rea

TAVOLO
TABLE
СТОЛИК

Sm 62.7x62.7xh35

Lg 122.7x62.7xh25

Finiture tavoli / Tables finishings / Отделки столиков



Palette strutture metallo
e piani ceramica a pag. 202
Page 202 metal frame
palette and ceramic tops
Палитра отделок
металлических структур
и керамических
столешниц на стр. 202



Rea

Struttura in metallo.

Finiture: versione ottone brunito verniciata a polveri, versioni ottone lucido e canna di fucile trattate con finitura galvanica e protezione trasparente. Piano in ceramica effetto marmo, spessore 0,6 cm ottenuto tramite cottura, spazzolatura e lucidatura meccanica. Superficie lucida, riflettente e antimacchia.

Metal frame.

Finishes: the burnished brass version features a powder-coated finish; the polished brass and gunmetal versions feature a galvanised finish with transparent protection. 0.6 cm-thick ceramic top with marble finish obtained by firing, brushing and mechanical polishing. Polished, reflective and stain-resistant surface.

Структура - металл.

Виды отделки: покраска в цвет полированной воронёной латуни; глянцевая латунь и саппа ді fucile (гальваника с прозрачным защитным покрытием). Столешница - керамика с эффектом мрамора, толщина 0,6 см, изготовлена посредством обжига, щеточной зачистки и механической полировки. Поверхность - глянцевая, отражающая и пятноустойчивая.

Rea Sm



Finitura in ottone brunito satinato
Satin burnished brass finishing
Отделка: полированная воронёная латунь



Finitura in canna di fucile lucido
Polished gunmetal finishing
Отделка: canna di fucile глянцевая



Finitura in ottone lucido
Polished brass finishing
Отделка: глянцевая латунь



Piano in ceramica effetto marmo Breccia
Marble finish ceramic top Breccia
Столешница: керамика с эффектом мрамора Breccia



Piano in ceramica effetto marmo Onice Bamboo
Marble finish ceramic top Onice Bamboo
Столешница: керамика с эффектом мрамора Onice Bamboo

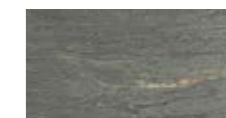

Piano in ceramica effetto marmo Majestic Marble 03
Marble finish ceramic top Majestic Marble 03
Столешница: керамика с эффектом мрамора Majestic Marble 03

Rea Lg



Finitura in ottone brunito satinato
Satin burnished brass finishing
Отделка: полированная воронёная латунь

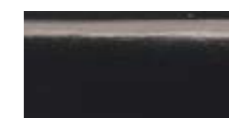

Finitura in canna di fucile lucido
Polished gunmetal finishing
Отделка: canna di fucile глянцевая



Finitura in ottone lucido
Polished brass finishing
Отделка: глянцевая латунь



Piano in ceramica effetto marmo Onice Bamboo
Marble finish ceramic top Onice Bamboo
Столешница: керамика с эффектом мрамора Onice Bamboo



Piano in ceramica effetto marmo Breccia
Marble finish ceramic top Breccia
Столешница: керамика с эффектом мрамора Breccia



Piano in ceramica Sahara Noir
Marble finish ceramic top Sahara Noir
Столешница: керамика с эффектом мрамора Sahara Noir

Finiture parti metalliche / Metal parts finishings / Отделка металлических частей



Ottone brunito satinato
Satin burnished brass
Полированная воронёная латунь



Canna di fucile lucido
Polished gunmetal
Глянцевая сanna di fucile



Ottone lucido
Polished brass
Глянцевая латунь



Cromo satinato/lucido
Polished/satin chrome
Сатинировый/блестящий хром

Finiture laminato / Laminate finishings / Отделка ламината



Ottone lucido
Polished brass
Глянцевая латунь
2006 vg LUC

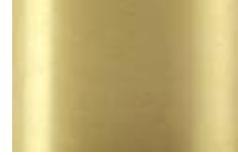

Ottone satinato
Satin brass
Латунь сатинированная
2003 vg SAT



Cromo satinato
Satin chrome
Хром сатинированный
2000 vg SAT



Canna di fucile lucido
Polished gunmetal
Глянцевая сanna di fucile
2007 vg CT



Canna di fucile satinato
Satin gunmetal
Сатинированная сanna di fucile
2012 vg SAT



Rame satinato
Satin copper
Медь сатинированная
2008 vg SAT

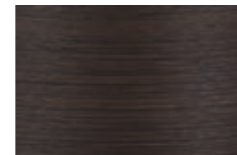

Wengé 4485 GHI
Wengé 4485 GHI
Венге 4485 GHI

Finiture piani ceramica / Ceramic top finishings / Отделка керамических столешниц



Breccia



Majestic Marble 03



Onice Bamboo

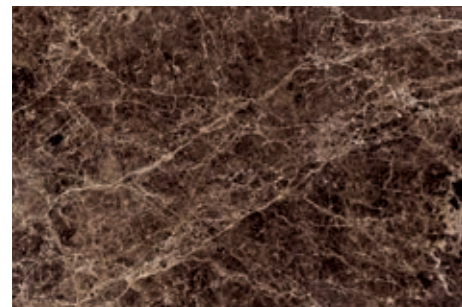

Emperador



Sahara Noir

Finiture piani marmo / Marble top finishings / Мраморные столешницы



Bianco Carrara

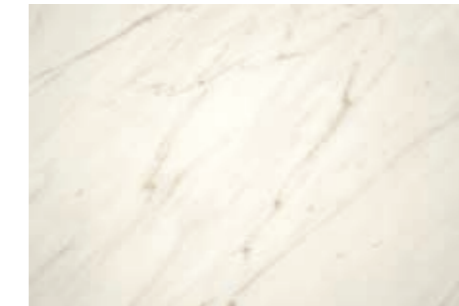

Bianco Calacatta

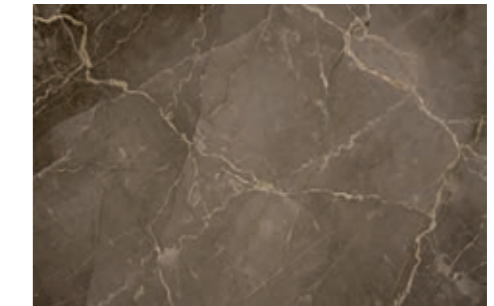

Moresco Imperiale

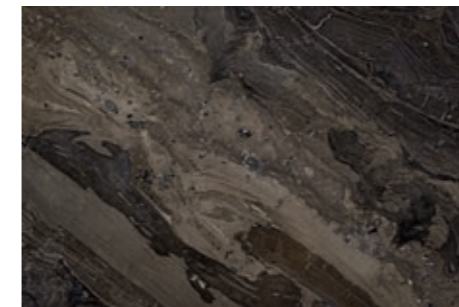

Cappuccino

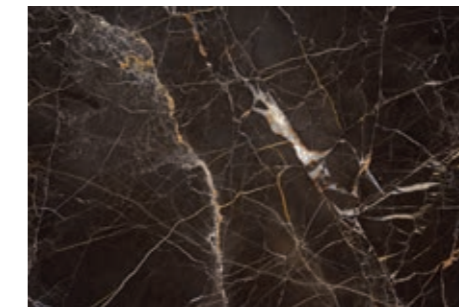

Noir Saint Laurent



Nero Marquina

Chiodini metallici / Metal nails / Металлические заклепки



130-1/3 ø 13
Bronzo sfumato
Shaded bronze
Полированная бронза



100-1/3 ø 10
Cromo lucido
Polished chrome
Глянцевый хром



130-1/3 ø 13
Oro invecchiato
Aged golden
Состарившееся золото



100-1/3 ø 10
Oro lucido
Polished gold
Глянцевое золото



Tessuti e pelli Fabrics and leathers Ткани и кожа

205

Vimini / Guatavita



Vimini/44 plus



Vimini/10 plus



Guatavita/100 extra



G075/102 elegant

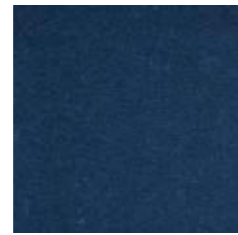

G075/416 elegant



Guatavita/600 extra



Java Cocoa F0496/08 lusso



Java Sesame F0496/45 lusso

Orfeo F7292 / Leonore F7291

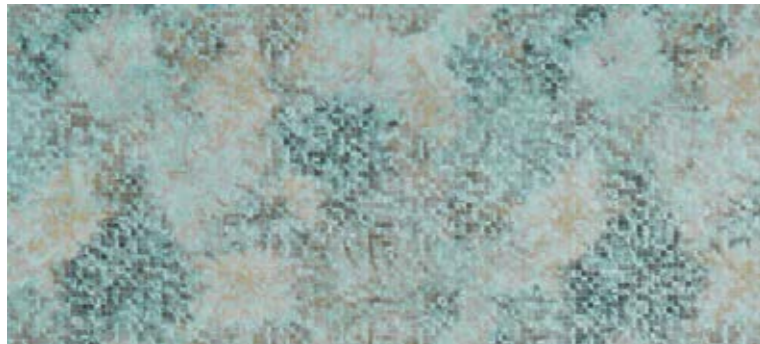

Orfeo F7292/01 Mint plus



Orfeo F7292/02 Silver plus

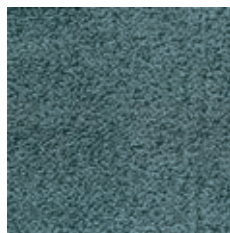

Leonore F7291/01 Ice extreme

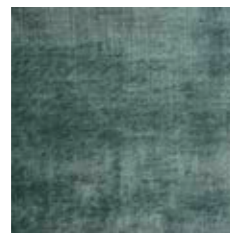

Vegas Velvet Plain 1403/61 elegant

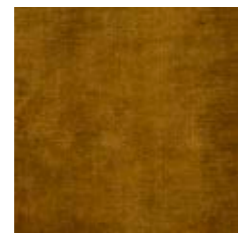

Vegas Velvet Plain 1403/02 elegant



Leonore F7291/03 Silver extreme



Tivoli/29 extra

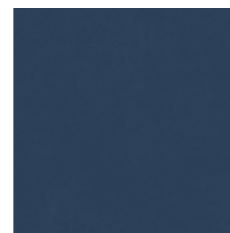

Tivoli/15 extra

Maui / 1952 Dalia



Maui Slate F1302/05 elegant



1952 Dalia/74 plus



Brooklyn/07 extreme

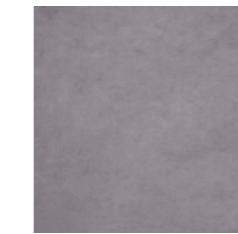

Brooklyn/46 extreme



Brooklyn/28 extreme

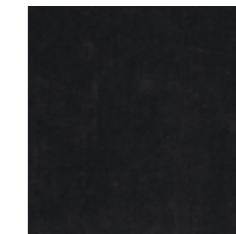

Brooklyn/15 extreme



Maui Natural F1302/04 elegant



1952 Dalia/90 plus

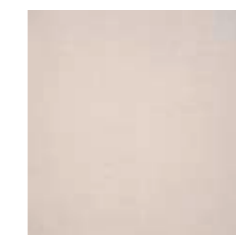

Brooklyn/22 extreme



Brooklyn/02 extreme



Brooklyn/19 extreme



Brooklyn/17 extreme

Exotica Tropicale



Exotica Tropicale Citron F1305/02 elegant



Exotica Tropicale Midnight F1305/04 elegant



8336/51 lusso



8336/3 lusso

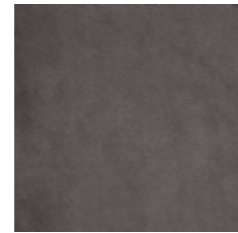

8336/5 lusso



8336/61 lusso

Diamond Luxury / Mirage Luxury

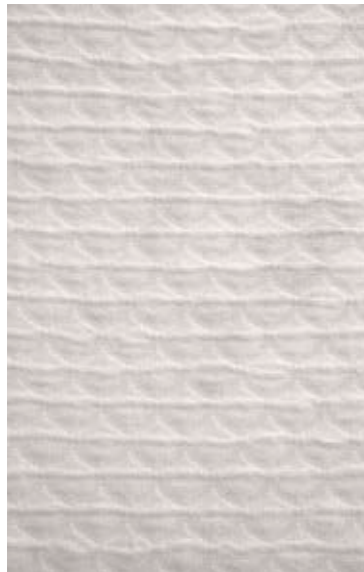

Diamond Luxury/01 extreme



Diamond Luxury/03 extreme



Diamond Luxury/04 extreme



Diamond Luxury/08 extreme

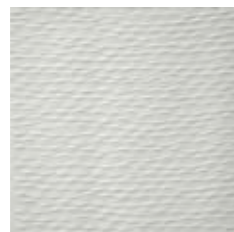

Mirage Luxury/01 extreme

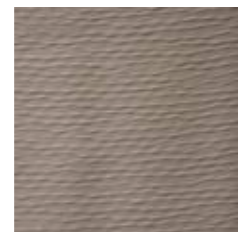

Mirage Luxury/03 extreme

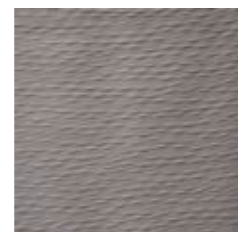

Mirage Luxury/04 extreme



Mirage Luxury/08 extreme

19558 Renzo / Karma / 19554 Don Rodrigo / 80723 Crusca



19558 Renzo/77 Porfido elegant

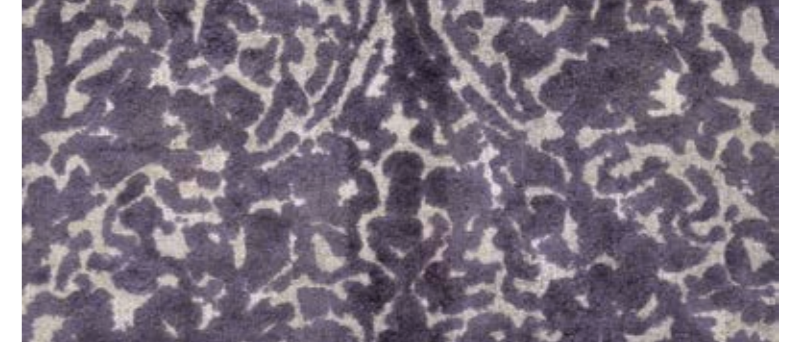

19554 Don Rodrigo/96 Prugna top



Karma/21 Tabacco elegant



Java Dusk F0496/12 lusso



Tivoli/11 extra

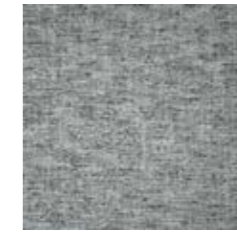

80723 Crusca/62 Grigio fumo extreme

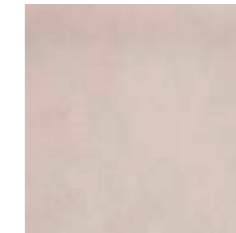

8336/51 lusso

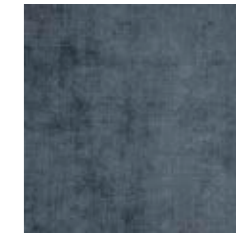

Vegas Velvet Plain 1403/84 elegant



19558 Renzo/50 Bronzo elegant



19554 Don Rodrigo/72 Opale top

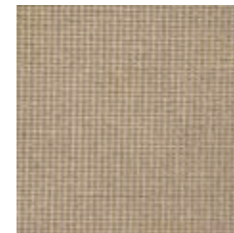

Karma/50 Platino elegant

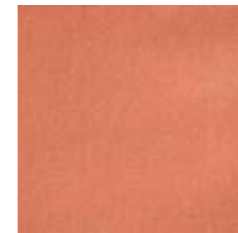

G075/456 elegant



Java Sesame F0496/45 lusso



80723 Crusca/46 Rame rosato extreme

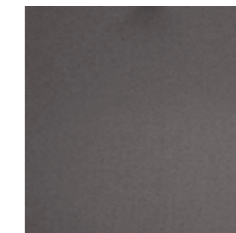

Tivoli/67 extra



8336/5 lusso

Bahamas / Small velvet / Kauai



Bahamas/4
top



Kauai Mocha
F1299/07
extra

Bilbi/22
extra

Bilbi/23
extra



Small Velvet/45076
top



Kauai Kingfisher
F1299/04
extra

Tivoli/29
extra

Tivoli/64
extra



Bahamas/3
top



Small Velvet/45072
top

Bilbi/11
extra

Bilbi/07
extra

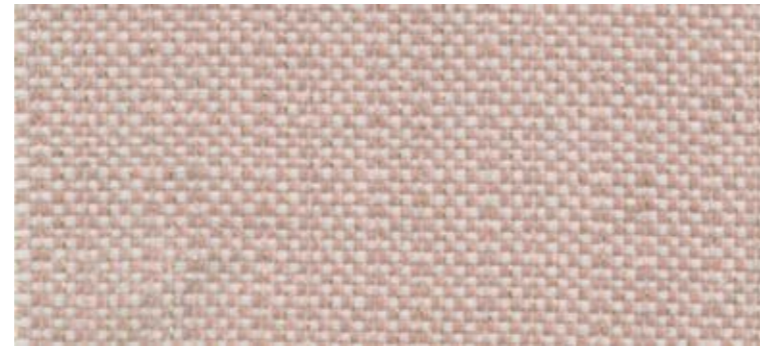

Kauai Blush F1299/01
extra



Small Velvet/45075
top

Tivoli/04
extra

Tivoli/40
extra

Struttura / Jungle velvet 1638 / Kauai

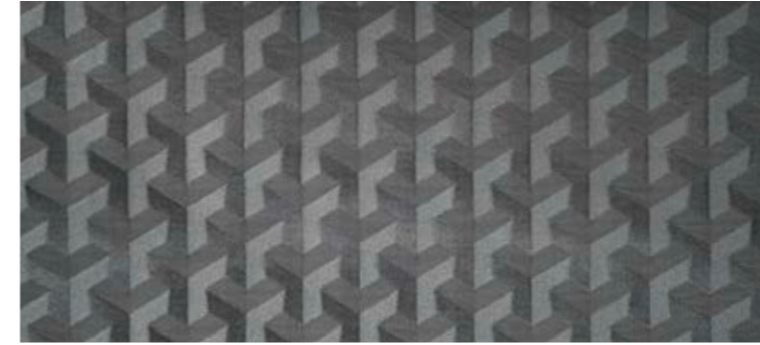

Struttura Pewter F1250/07
extra



Kauai Mineral
F1299/06
extra

G075/414
elegant

G075/312
elegant



Jungle Velvet 1638/05
elegant



Kauai Citron F1299/03
extra

Java Dove F0496/10
lusso

Java Mahogany
F0496/27
lusso



Struttura Champagne F1250/01
extra



Kauai Charcoal
F1299/02
extra

G075/208
elegant

G075/234
elegant



Jungle Velvet 1638/07
elegant



Kauai Mocha
F1299/07
extra

Java Putty F0496/41
lusso

Java Spice F0496/48
lusso

La Moulade NCF4280



La Moulade NCF4280/05 Blue/Linen top



Vegas Velvet Plain 1403/63 elegant



Vegas Velvet Plain 1403/61 elegant



Java Straw F0496/49 lusso



Java Sesame F0496/45 lusso

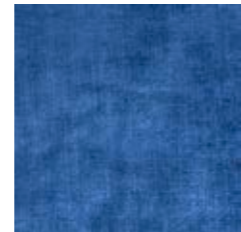

Vegas Velvet Plain 1403/78 elegant

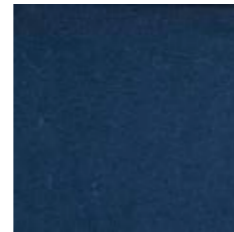

G075/416 elegant



Java Eau de nil F0496/14 lusso



Java Putty F0496/41 lusso

La Moulade NCF 4280/03 Beige/Teal/Chocolate top

Vegas Velvet Plain 1403

elegant



38

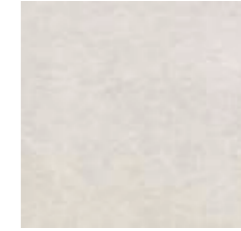

04



01



83



63

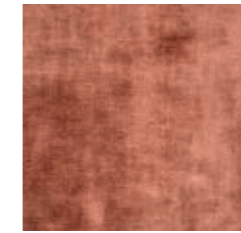

54



47



02

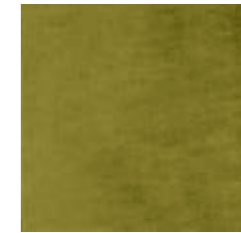

67



68



48



39

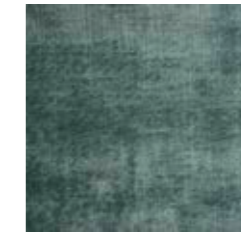

61



84



78



11



241

Brooklyn

extreme

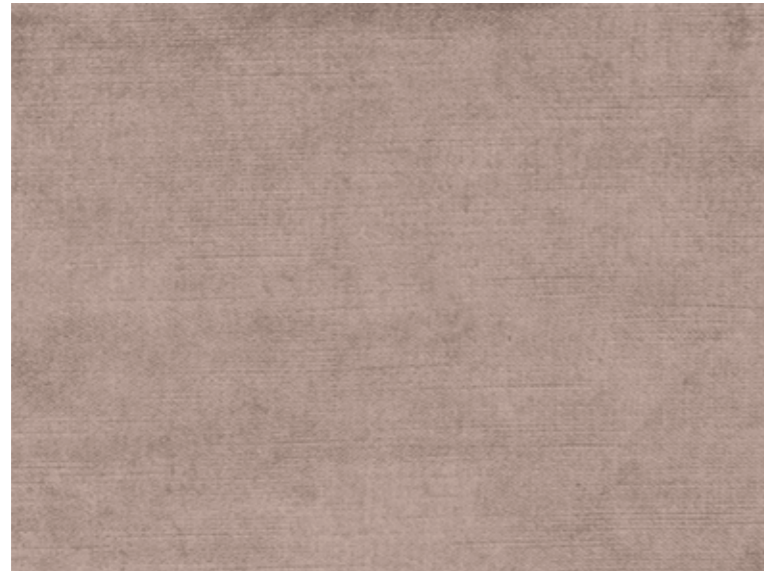

22



41



02

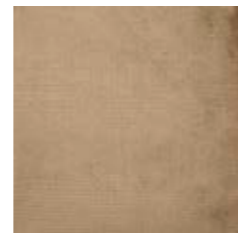

21

28



18



19



20



07



28



23



17



13

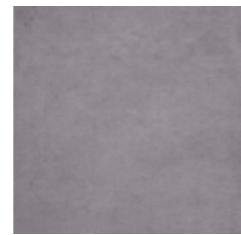

46

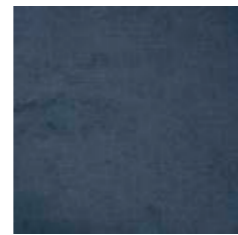

24



33



15

Tivoli

extra



09



24



29



04



02



08



09



17



40



42



43



46



49



15



64



11

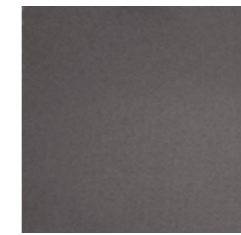

67

Bilbi

extra



19

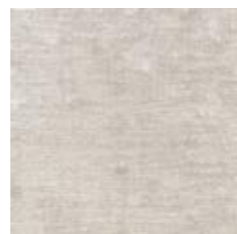

05

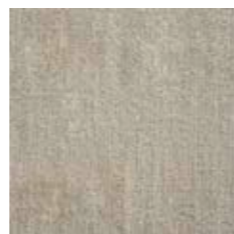

07

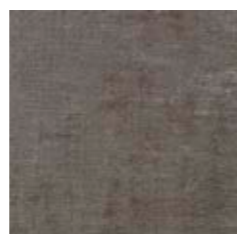

02

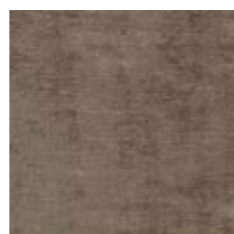

08

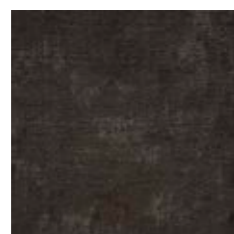

09

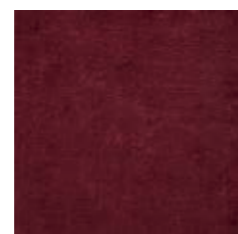

29



11

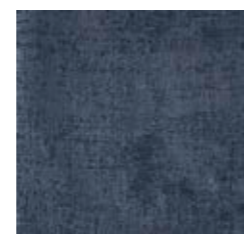

17



19



35



34

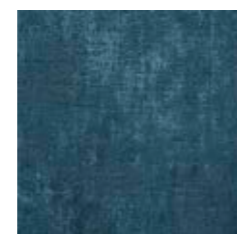

16

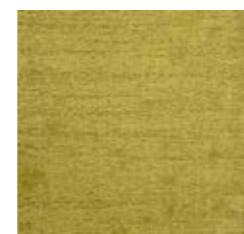

26

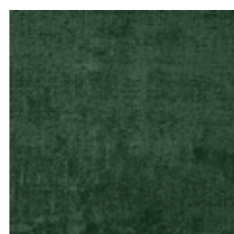

23

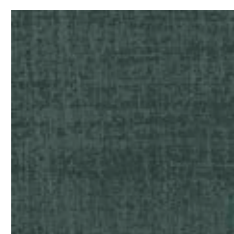

22

G075

elegant



208



003



102



230



857



312



338



456



462



641



452



824

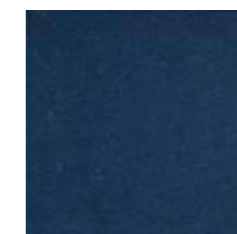

416

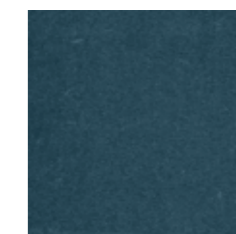

414



129

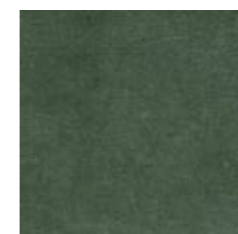

234

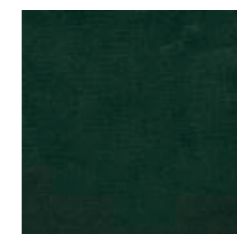

787

8336

lusso

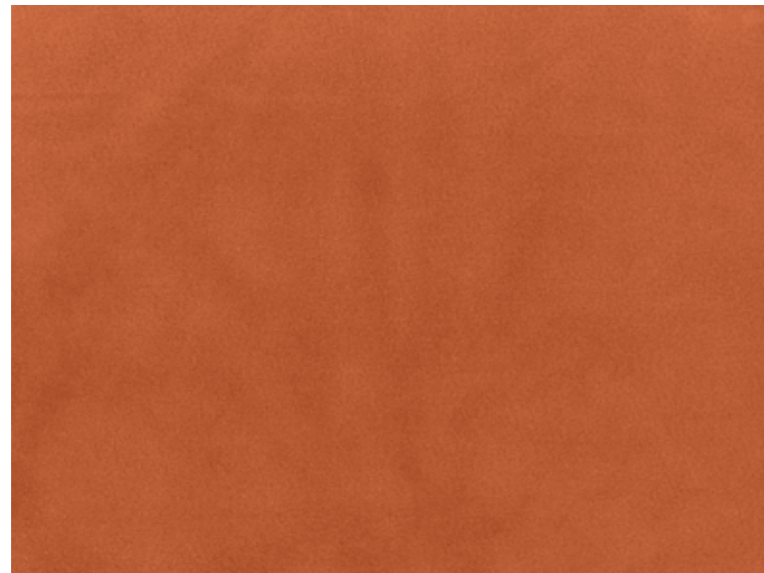

15



51



41



3



40



15



31

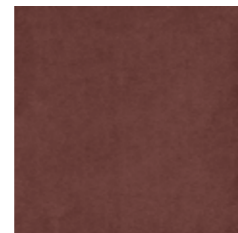

60



11

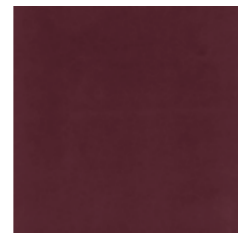

57



29



27



61

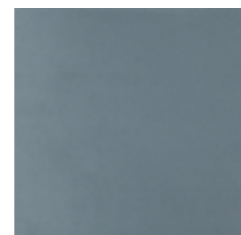

55



53



5



10

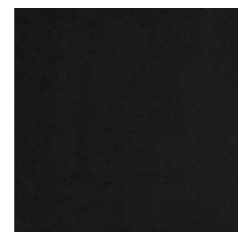

32

Trapuntature per art. 8336 / Upholstery stitching patterns
for item 8336 / Прошивки для арт. 8336

super

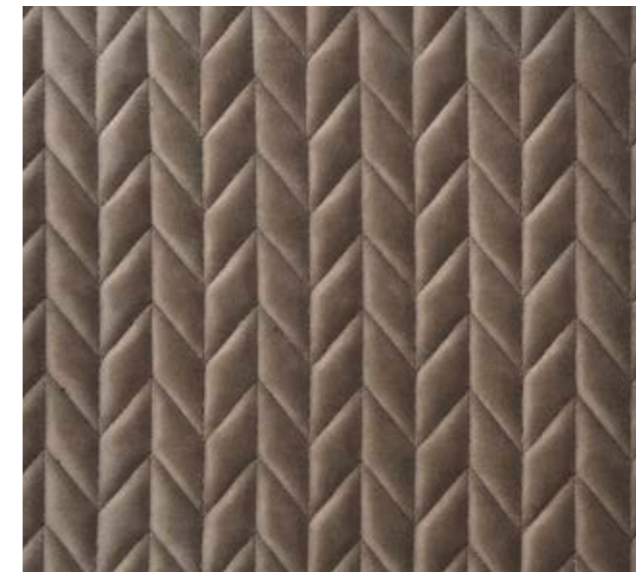

1456



1468



1469



1470

Al codice della trapuntatura scelta
va associato il codice colore
dell'art. 8336

Along with the quilting style
chosen, please indicate the colour
code of the fabric (art. 8336)

Код выбранного типа прошивки
должен сочетаться с кодом
цвета ткани арт.8336

Java

lusso



Pewter F0496/38



Buff F0496/03



Putty F0496/41



Sesame F0496/45

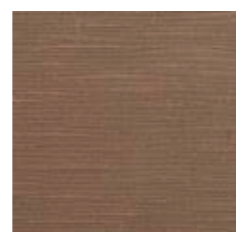

Cocoa F0496/08



Spice F0496/48

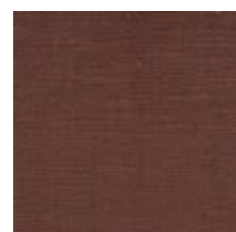

Mahogany F0496/27

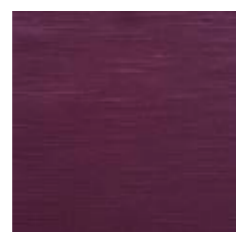

Grape F0496/19



Heather F0496/20



Eau De Nil F0496/14



Dusk F0496/12

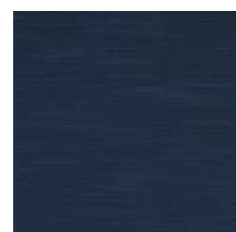

Midnight F0496/29

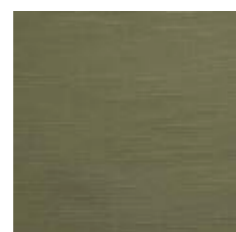

Moss F0496/33



Straw F0496/49



Dove F0496/10

Basic



443 Mauritius

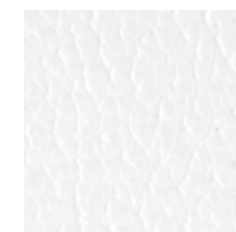

401 Bianco



417 Red



419 Burgundy

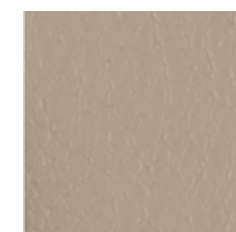

408 Fumo

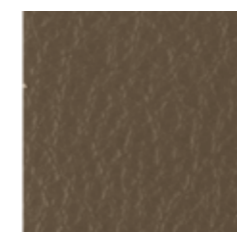

446 Military

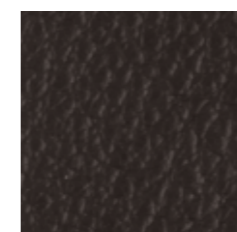

420 Testa di Moro

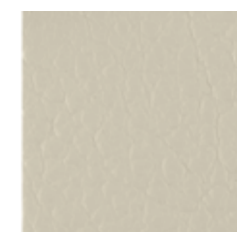

422 Acqua

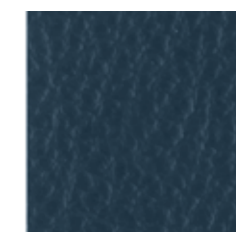

440 Denim

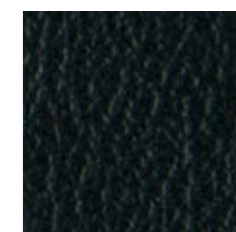

423 Nero

Flower

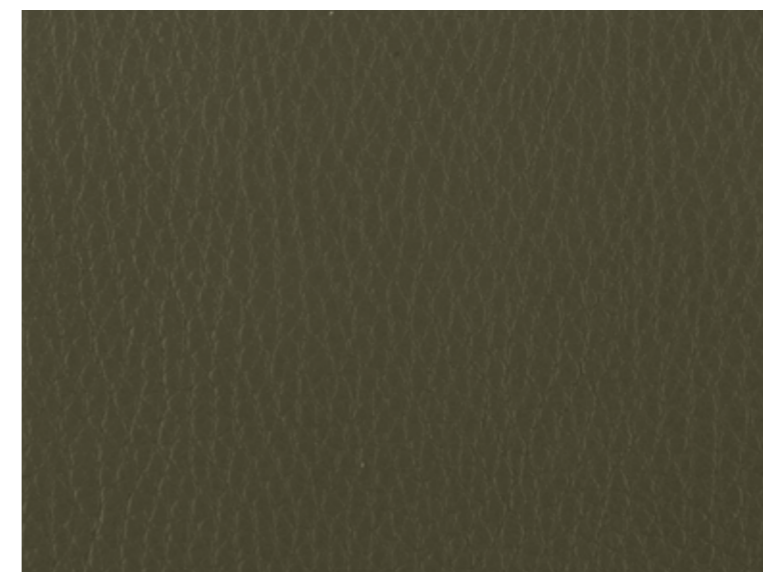

547 Musk



501 Bianco Ottico

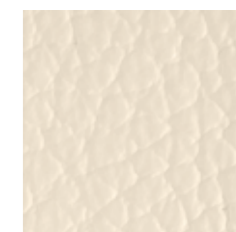

524 Magnolia

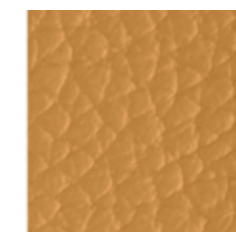

535 Cornflake



529 Fango

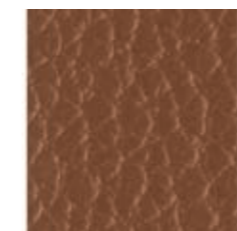

507 Terra

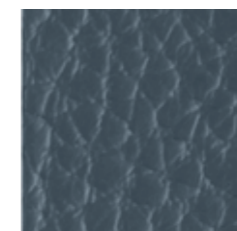

540 Slate Grey

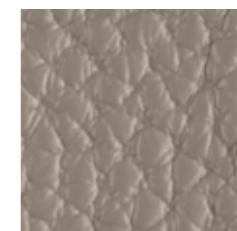

532 Ecrú



519 Antracite

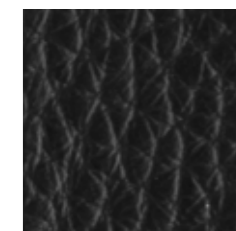

516 Nero



Moon



692 Colvert



601 Bianco Ottico



637 Caffelatte



619 Giallino

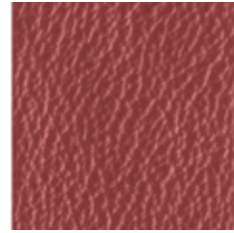

613 Mattone



662 Fondotinta



610 Mogano



660 Asfalto



651 Rosa Antico



622 Nero

Old

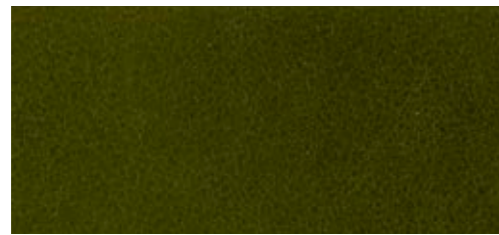

1

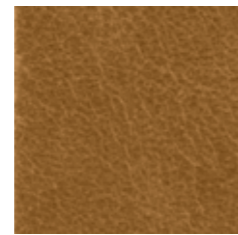

3

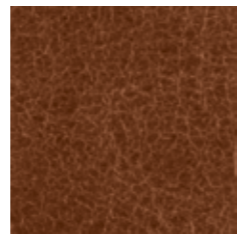

6

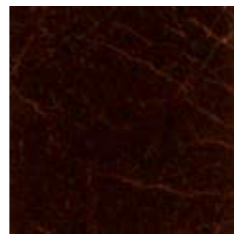

5

Lux

top

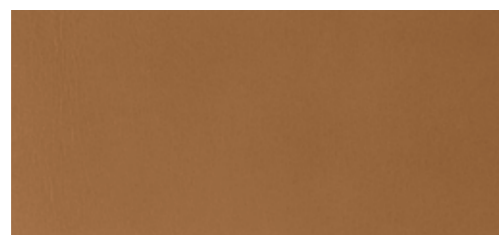

2434



2408

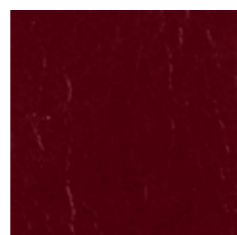

2407

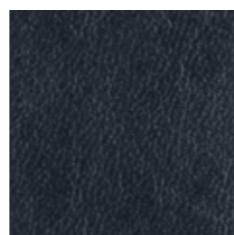

2438

222

Pelli Leathers Кожа Domingo—Luxury

Rétro

extreme



4025

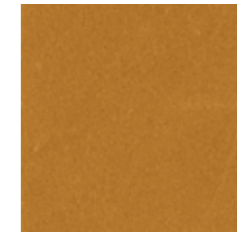

4022

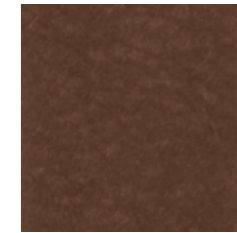

4019

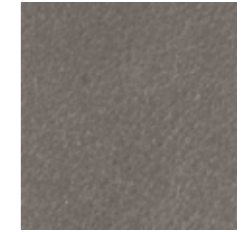

4007

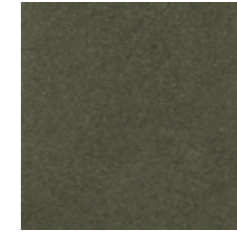

4018

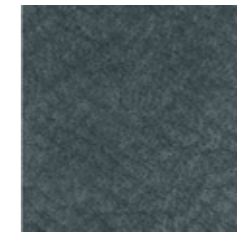

4020



4027

Nabuk

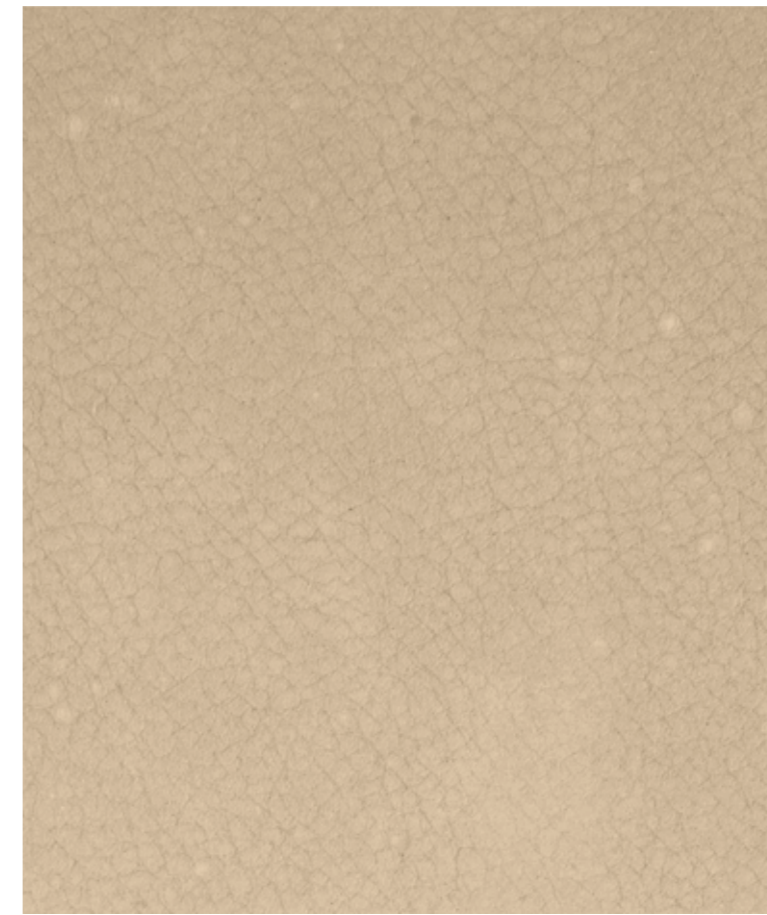

3

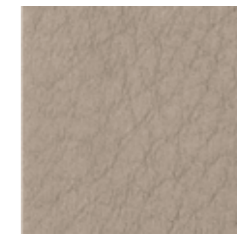

15

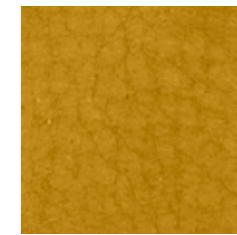

22



8

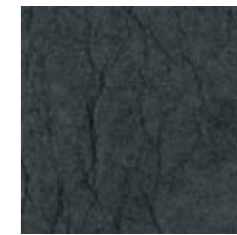

12



16

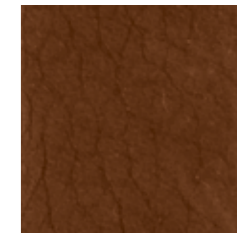

27
223

Informazioni tecniche tessuti / Technical data on fabrics / Технические характеристики тканей

19552 Dalia

83% VI - 13% SE - 4% PA
371gr/m²
↑63 cm ↔68.5 cm
H 137 cm

19554 Don Rodrigo

57% VI - 28% LI - 15% PL
327 gr/m²
↑36 cm ↔35 cm
H 138 cm

19558 Renzo

55% VI - 45% PL
264 gr/m²
↑2.3 cm ↔2.2 cm
H 140 cm

80723 Crusca

41% VI - 25% CO - 16% LI - 14% PL - 4% PA
550 gr/m²
H 140 cm

8336

100% PL
460 gr/m²± 5%
H ≥140 cm

Bahamas

55% CO - 45% VI
614 gr/m²
↑62 cm ↔66 cm
H 140 cm

Bilbi

65% PC - 35% PL
557 gr/m²±5%
H 140 cm ±2%

Brooklyn

19% CO - 65% VI - 16%PL -
Pile 100% VI
486 gr/m²
H 140 cm

Diamond Luxury

70% PL FR - 30% PL
230 gr/m²
↑2.5 cm ↔2.5 cm
H 305/310 cm

Exotica Tropicale

63% PL - 21% VI - 16% CO
571 gr/m²
↑40 cm ↔34.5 cm
H 138 cm

G075

100% CO
580 gr/m²± 2%
H 140 cm ± 2%

Guatavita

100% PL
350 gr/m²
H 140 cm

Java

62% CO - 38% PL
235 gr/m²
H 148 cm

Jungle Velvet 1638

85% PL - 15% VI
571 gr/m²
↑60.5 cm ↔70 cm
H 140 cm ± 2%

Karma

54% PL - 22% CO - 13% VI - 9% PC - 2% ME
443 gr/m²
H 140 cm

Kauai

46% CO - 42% PL - 12% VI
560 gr/m²
H 134 cm

La Moulade NCF4280

79% VI - 21% PL
622 gr/m²
↑33 cm ↔33 cm
H 134 cm

Leonore F7291

50% VI - 28% CO - 22% PL
651 gr/m²
H 140 cm

Maui

48% PL - 30% VI - 22% CO
558 gr/m²
↑3.7 cm ↔3.4 cm
H 137 cm

Mirage Luxury

50% PL FR - 50% PL
270 gr/m²
H 300/305 cm

Orfeo F7292

60% VI - 35% CO - 5% PL
490 gr/m²
H 141 cm

Small Velvet

Pile 100% VI
Warp 100% PL
207 gr/m²
↑3 cm ↔3 cm
H 142 cm

Struttura

35% VI - 33% PL - 32% CO
310 gr/m²
↑2.9 cm ↔4.7 cm
H 139 cm

Tivoli

60% CO - 40% PL
218 gr/m²
H 137 cm

Vegas Velvet Plain 1403

55% VI - 45% CO
780 gr/m²±4%
H 140 cm

Vimini

100% PL
350 gr/m²
↑16.5 cm ↔16 cm
H 140 cm

Informazioni tecniche pelli / Technical data on leather / Технические характеристики кожи

Basic

pelle bovina mezzo fiore stampata
spessore: 0.8-1.0 mm
superficie media: 4.8-5.0 m²

corrected and embossed cowhide for enhanced grain consistency

thickness: 0.8-1.0 mm
average size of each hide is around 4.8-5.0 m²

тисненая полулицевая кожа крупного рогатого скота

толщина: 0,8-1,0 мм
средняя площадь: 4,8-5,0 м²

Flower

pelle bovina mezzo fiore stampata
spessore: 0.8-1.0 mm
superficie media: 4.8-5.0 m²

corrected and embossed cowhide for enhanced grain consistency

thickness: 0.8-1.0 mm
average size of each hide is around 4.8-5.0 m²

тисненая полулицевая кожа крупного рогатого скота

толщина: 0,8-1,0 мм
средняя площадь: 4,8-5,0 м²

Old

pelle bovina a grana fine
spessore: 1.2 mm
superficie media: 6.0 m²

Fine-grained cowhide for enhanced grain consistency

thickness: 1.2 mm
average size of each hide is around 6.0 m²

мелкозернистая кожа крупного рогатого скота

толщина: 1,2 мм
средняя площадь: 6,0 м²

Lux

natural cowhide
thickness: 0.9-1.1 mm
average size of each hide is around <5.0 m²

мелкозернистая кожа крупного рогатого скота

толщина: 0,9-1,1 мм
средняя площадь: <5,0 м²

Moon

pelle bovina mezzo fiore a grana naturale
spessore: 0.9-1.1 mm
superficie media: 4.8-5.0 m²

lightly buffed natural grain cowhide

thickness: 0.9-1.1 mm
average size of each hide is around 4.8-5.0 m²

натурально-зернистая полулицевая кожа крупного рогатого скота

толщина: 0,9-1,1 мм
средняя площадь: 4,8-5,0 м²

full grain nubuck cowhide

thickness: 1.3 mm
average size of each hide is around 6.0 m²

нубукированная мелкозернистая лицевая кожа крупного рогатого скота

толщина: 1,3 мм
средняя площадь: 6,0 м²

Rétro

pelle bovina
spessore: 0.9-1.1 mm
superficie media: 4.8-5.0 m²

cowhide with a distressed vintage effect

thickness: 0.9-1.1 mm
average size of each hide is around 4.8-5.0 m²

кожа крупного рогатого скота

толщина: 0,9-1,1 мм
средняя площадь: 4,8-5,0 м²

Tessuti e pelli Fabrics and leathers

Кожа и кожа

Domingo—Luxury

Palazzo Milzetti Faenza

Museo Nazionale dell'età neoclassica in Romagna



"Dai diamanti non nasce niente, dal letame nascono i fiori". Questo deve aver pensato e sperato il conte Nicola Milzetti quando, nel 1792, affidò all'architetto Giuseppe Pistocchi l'incarico di costruire il proprio palazzo partendo dalle diroccate case di famiglia danneggiate dal sisma nel 1781. I lavori si protrassero fino al 1808 quando la famiglia Milzetti lo vendette, dopo aver speso gli ultimi 20 anni ad impreziosirlo e adornarlo di pitture e stucchi di grottesche e trompe l'oeil che nulla hanno da invidiare ai più bei palazzi romani o di altre capitali europee. Raffinato ed elegante, mai con eccesso o arroganza, Palazzo Milzetti rimane uno degli edifici più interessanti e al tempo stesso sconosciuti dell'intera Romagna. Dal 2001 sede del Museo dell'età neoclassica in Romagna, ci dona un pretesto per farsi visitare e ammirare.

"Nothing grows out of diamonds, but flowers spring up from manure": this must have been the thought and the hope that in 1792 pushed

Earl Nicola Milzetti to commission architect Giuseppe Pistocchi the construction of his Palace after the 1781 earthquake had greatly damaged his family's home. The building process lasted until 1808, when the Milzetti family sold the palace after having spent twenty years embellishing and decorating it with frescoes, Grottesque stuccoes and trompe l'oeil that are no less gorgeous than what you find in noble palaces in Rome or in other European capitals. Sophisticated and elegant without excess nor arrogance, Palazzo Milzetti remains one of the most interesting, although little known, buildings in the Romagna region. Since 2001, it has hosted the Museum of the Neoclassic Period in Romagna, which should be a reason in itself to plan a visit.

"Ничего не родят алмазы, а цветы из грязи рождаются". Так, полагается, думал и желал граф Никола Мильцетти, когда в 1792 году поручил архитектору Джузеппе Пистокки построить для себя дворец

из руин, которые оставались на месте домов, принадлежавших его семейству и разрушенных землетрясением в 1781 году. Работы велись до 1808 года, когда семейство Мильцетти решило продать дворец, после того, как на протяжении последних 20 лет украшало его росписями, лепниной, изображающей гротескные фигуры, и тромплями, которые своей красотой не уступают убранству самых красивых дворцов Рима или других европейских столиц. Роскошный и элегантный, и при этом лишенный надменности и излишеств, Палаццо Мильцетти остается одним из самых прекрасных и в то же время мало известных зданий в Романье. С 2001 года в стенах дворца располагается музей неоклассического искусства Романьи, предоставляя нам тем самым повод посетить его, чтобы восхититься его красотой.

Palazzo Rasponi delle Teste Ravenna



Quasi tre secoli di attenta e ricercata costruzione, ci hanno restituito uno dei palazzi più belli dell'intera Ravenna. Dietro una severa e classicista facciata di quasi 70 metri, si cela un cuore morbido di barocco e rococò, quasi a testimoniare l'incessante scorrere di tre lunghi secoli, in cui la famiglia Rasponi attraversò altalenanti periodi di grandezza e importanza. Doppi volumi si intersecano con decorazioni sinuose ed inusuali e la rigida simmetria esterna dialoga felicemente con la morbidezza degli ambienti interni. Dopo un attento restauro, ad oggi, i suoi sontuosi spazi, di proprietà del Comune di Ravenna, sono dedicati a mostre, concerti ed eventi culturali.

It took almost three centuries to build this Palace, recently restored to the grandeur that makes it one of the most striking buildings in Ravenna. A 70-metre wide classically rigorous façade hides a soft rococo and baroque heart, revealing the time span over which the Rasponi family saw to the completion

of their family residence despite periods of decreasing financial and social influence. Double volumes intersect with sinuous and unusual decorations while the rigid external symmetry happily interacts with the softness of the interiors. Today, its sumptuous spaces, owned by the Municipality of Ravenna, are dedicated to exhibitions, concerts and cultural events.

Почти три века ушло на усердное и тщательное строительство, в результате которого мы получили один из самых красивых дворцов Равенны. Строгий фасад, выполненный в стиле классицизма и простирающийся на 70 метров, скрывает нежное сердце барокко и рококо, свидетельствующих о непрерывном течение трех веков, за которые семейство Распони познало чередующиеся периоды величия и падения. Двойные объемы пересекаются с извилистым и необычным декором, а жесткая внешняя

симметрия гармонично переключается с мягкостью интерьеров. После тщательной реставрации в роскошных интерьерах дворца, который на сегодняшний день принадлежит мэрии Равенны, проходят выставки, концерты и культурные мероприятия.

DOMINGO®

Strada della Romagna, 285
61121 PESARO (ITALY)
T +39 0721 208080
info@domingo.it
www.domingo.it

Direzione artistica Art direction	Valentina Bigiarini & Francesca Grassi
Product design	Arch. Mattia Santucci Rimini
Grafica Graphic design	ma:design Pesaro
Foto Photo	Mauro Foli Cervia
Stampa Print	Grapho 5 Fano
	 Palazzo Rasponi delle Teste Ravenna Palazzo Milzetti Faenza - Museo Nazionale dell'età neoclassica in Romagna Su concessione del Ministero per i beni e le attività culturali e per il turismo - Polo Museale dell'Emilia-Romagna
Ringraziamento speciale a special thanks to	
Cartoline Postcards pag.8-50-76-120-130-142-162	Deirdre Dyson Exclusive Carpets and Rugs www.deirdredyson.com
Edizione 1 Issue 1	Novembre 2020 November 2020

Luxury living

domingo.it