

OMBRA

design GEA AVITABILE



L'ombra è l'alone che un oggetto proietta e che ne espande la presenza. Le ombre fanno parte del nostro vivere quotidiano, ci infondono sicurezza, e qualche volta un riparo. Spesso un'ombra mette in luce dettagli altrimenti non visibili. A questo si ispirano le geometrie della collezione Ombra, una piccola architettura che dialoga con lo spazio circostante.

A shadow is the halo around an object that extends its presence. Shadows are part of our everyday lives, giving us security and sometimes protection. Often a shadow highlights details that would otherwise be invisible. This is the inspiration behind the geometry of the Ombra series, a small piece of architecture in dialogue with the space around it.

OMBRA

design GAE AVITABILE

1P / 1S



ANGOLO / CORNER



2P / 2S



3P / 3S



POUF



OMBRA

design GAE AVITABILE

1P / 1S

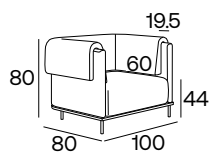

100 cm / 39.37"
80 cm / 31.50"
80 cm / 31.50"
44 cm / 17.13"
60 cm / 23.62"
19.5 cm / 7.68"

 XX kg / XX Lb

 0.66 m³

 **10.50 mtl**
tessuto cliente /
customer fabric
H 140 cm

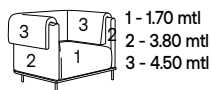

1 - 1.70 mtl
2 - 3.80 mtl
3 - 4.50 mtl

19.53 m²
pelle cliente /
customer pelle

2P / 2S

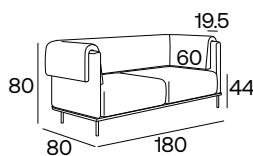

180 cm / 70.87"
80 cm / 31.50"
80 cm / 31.50"
80 cm / 31.50"
44 cm / 17.13"
60 cm / 23.62"
19.5 cm / 7.68"

 XX kg / XX Lb

 1.19 m³

 **15.00 mtl**
tessuto cliente /
customer fabric
H 140 cm

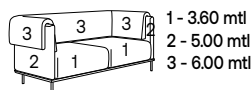

1 - 3.60 mtl
2 - 5.00 mtl
3 - 6.00 mtl

27.90 m²
pelle cliente /
customer pelle

3P / 3S

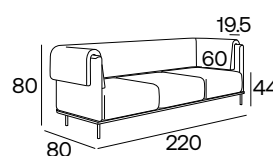

220 cm / 86.61"
80 cm / 31.50"
80 cm / 31.50"
80 cm / 31.50"
44 cm / 17.13"
60 cm / 23.62"
19.5 cm / 7.68"

 XX kg / XX Lb

 1.45 m³

 **18.50 mtl**
tessuto cliente /
customer fabric
H 140 cm

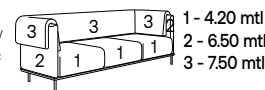

1 - 4.20 mtl
2 - 6.50 mtl
3 - 7.50 mtl

34.41 m²
pelle cliente /
customer pelle

ANGOLO / CORNER

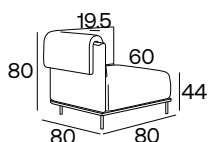

80 cm / 31.50"
80 cm / 31.50"
80 cm / 31.50"
44 cm / 17.13"
60 cm / 23.62"
19.5 cm / 7.68"

 XX kg / XX Lb

 0.53 m³

 **9.00 mtl**
tessuto cliente /
customer fabric
H 140 cm

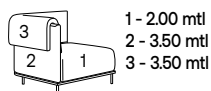

1 - 2.00 mtl
2 - 3.50 mtl
3 - 3.50 mtl

16.74 m²
pelle cliente /
customer pelle

POUF

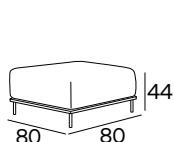

80 cm / 31.50"
80 cm / 31.50"
44 cm / 17.13"

 XX kg / XX Lb

 0.29 m³

 **2.00 mtl**
tessuto cliente /
customer fabric
H 140 cm

3.72 m²
pelle cliente /
customer pelle

OMBRA

design GAE AVITABILE

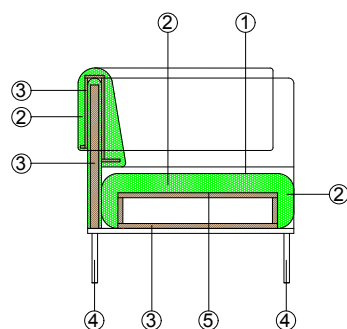

MATERIALI / MATERIALS

- 1 - tessuto/pelle
- 2 - poliuretano espanso indeformabile densità variabili e strato di fibra di dacron® 100 gr
- 3 - telaio in multistrato di legno
- 4 - struttura in metallo verniciato, h 18 cm
- 5 - cinghie elastiche intrecciate

- 1 - fabric/leather
- 2 - high resilience polyurethane foam var. densities and dacron® fiber 100 gr layer
- 3 - structural frame in plywood
- 4 - varnished metal frame, h 18 cm
- 5 - elastic webbing

PIEDI / FEET



CARATTERISTICHE / TECHNICAL FEATURES

SFODERABILITÀ / COVER REMOVAL



VARIANTI / VERSIONS



STRUTTURA METALLO / METAL FRAME



Ral colore a scelta
Ral color of your
choice